

# CRACK FOKKER

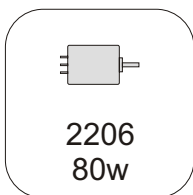

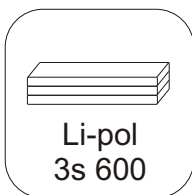

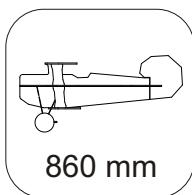

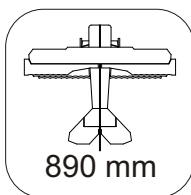
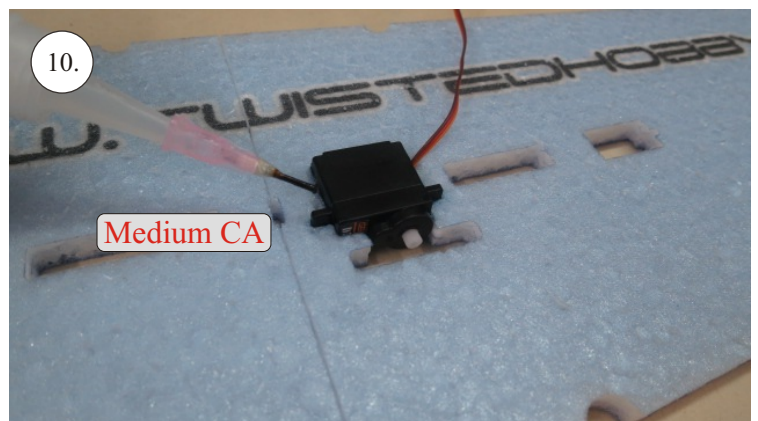
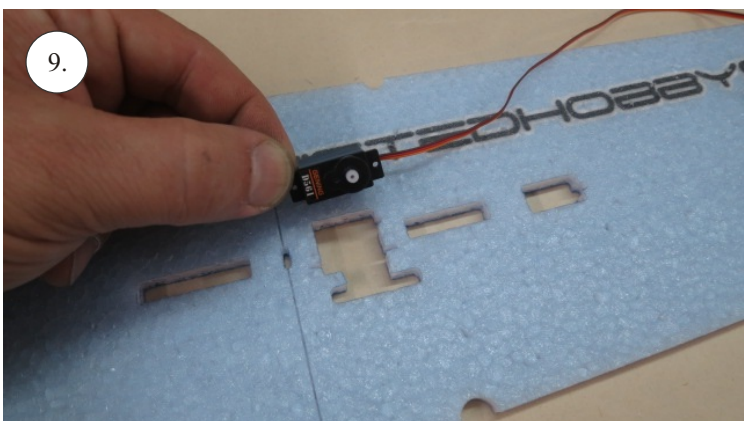
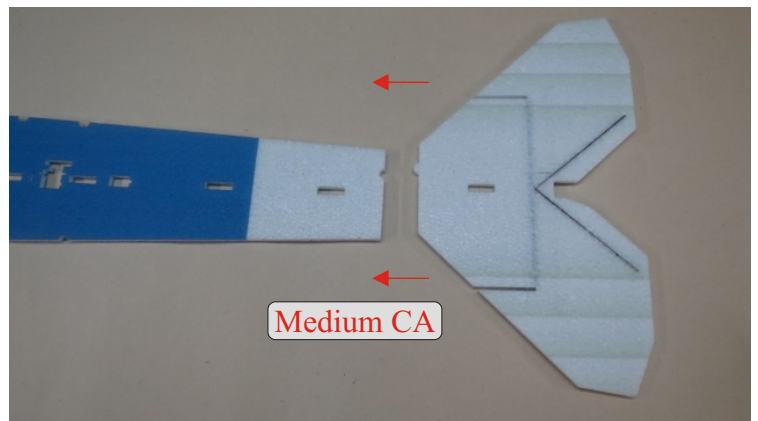
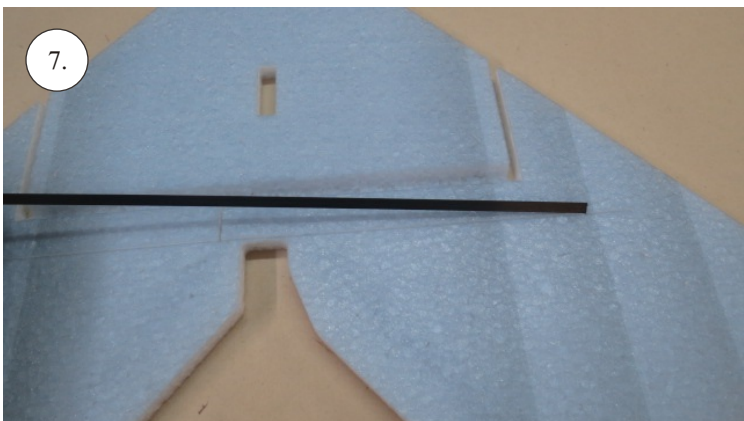
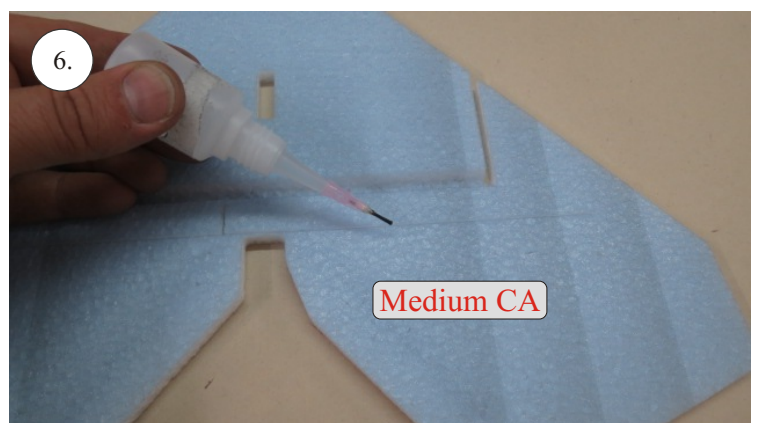
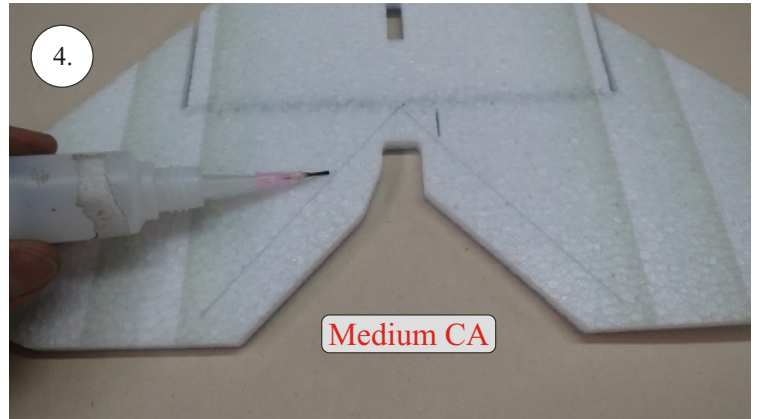
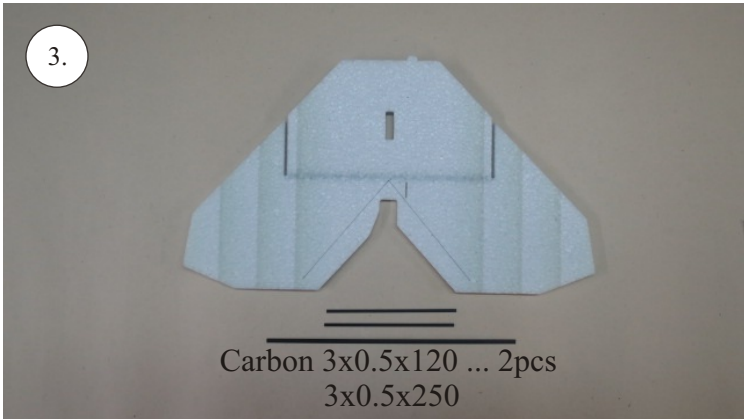
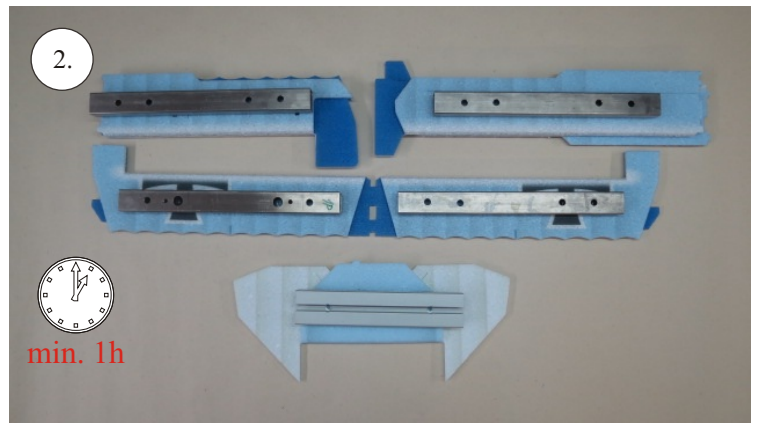
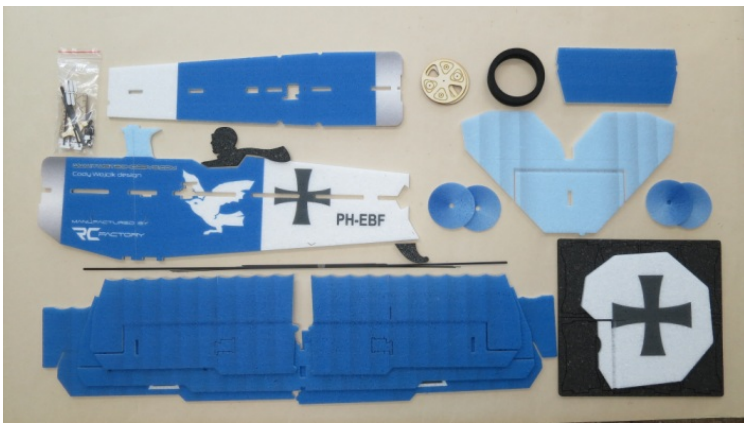
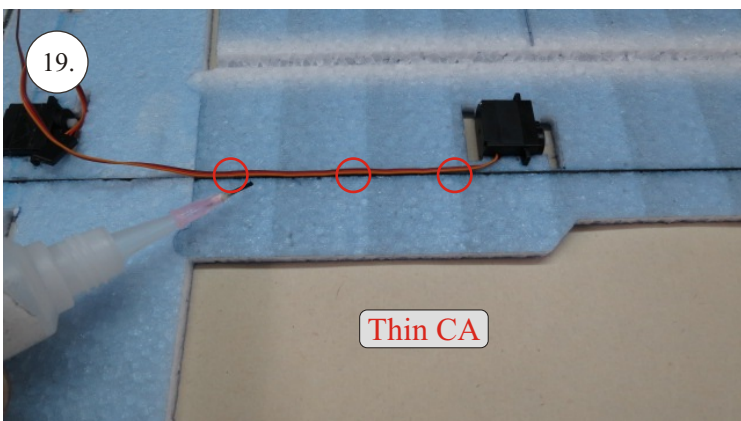
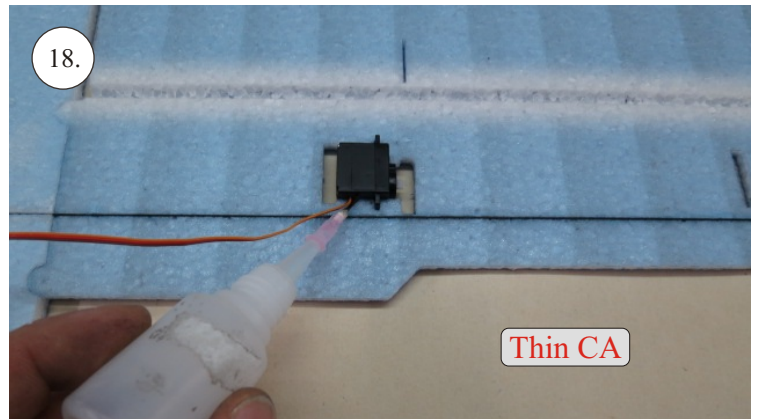
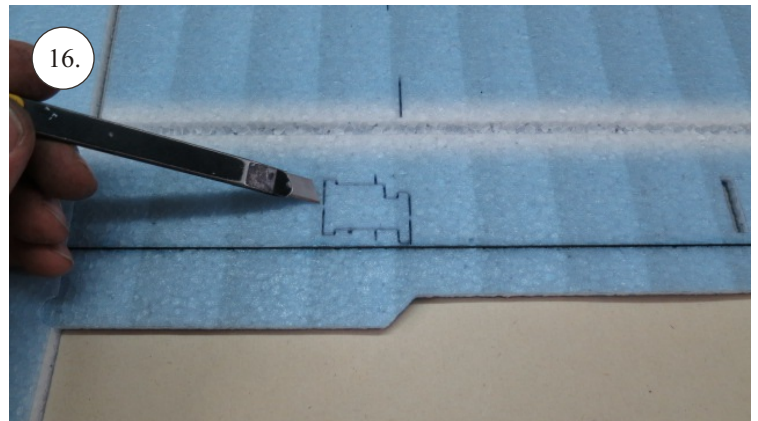
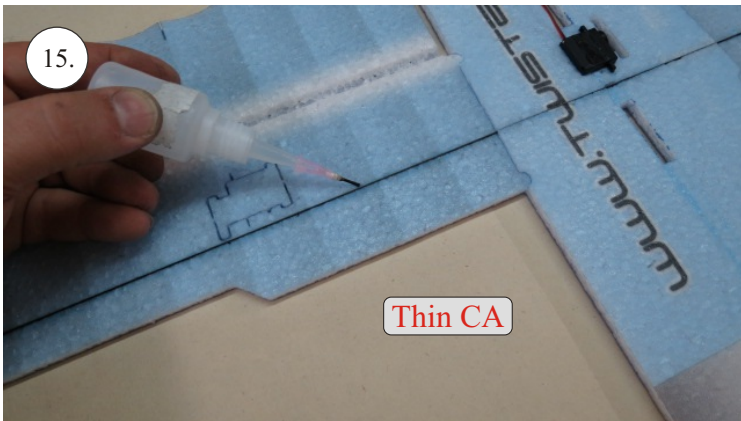
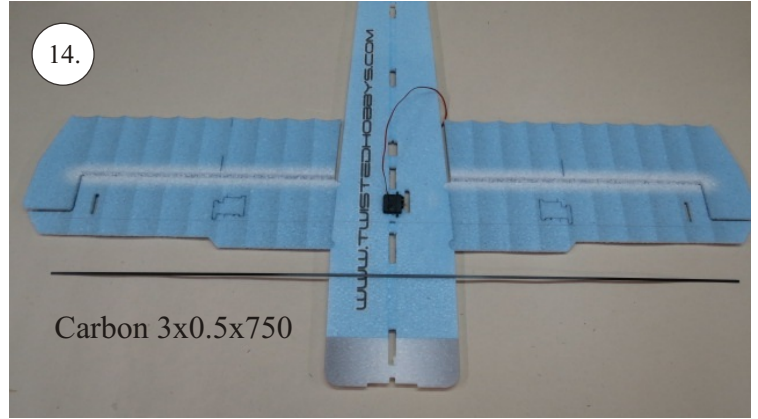
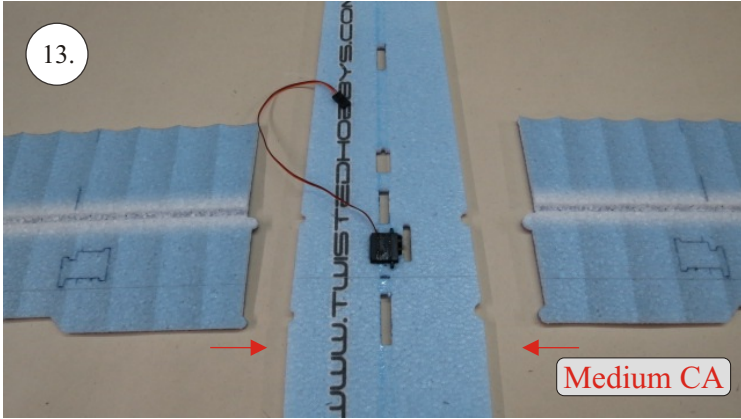
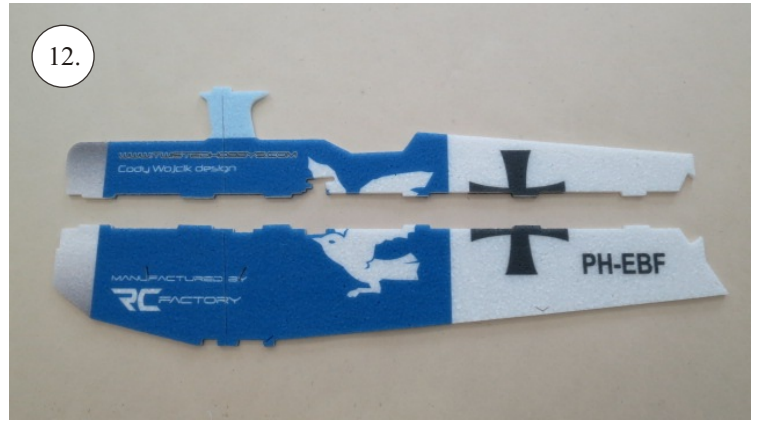
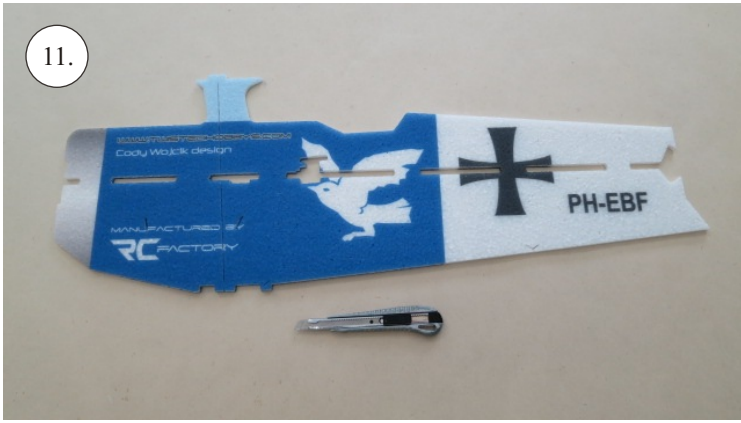
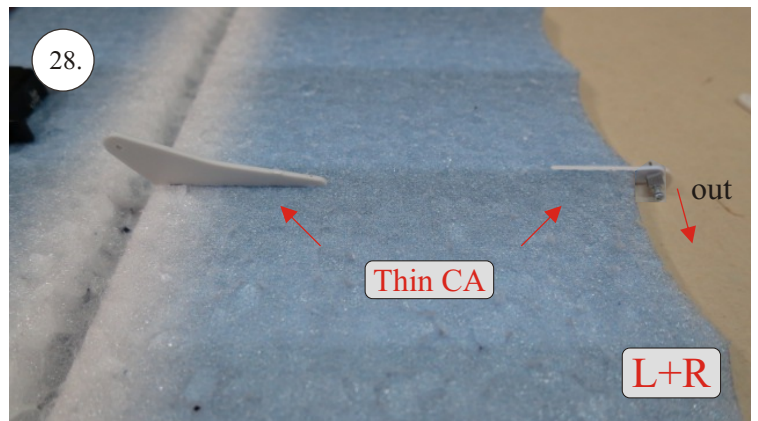
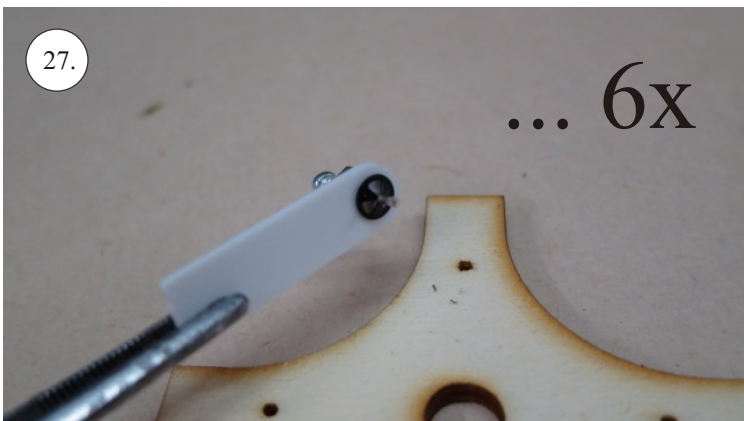
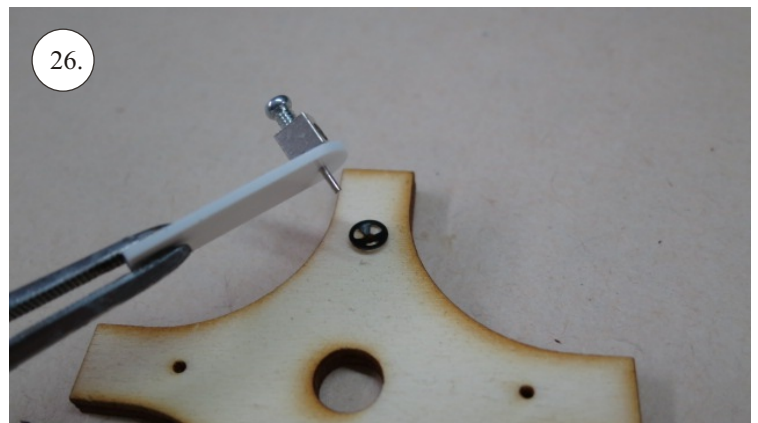
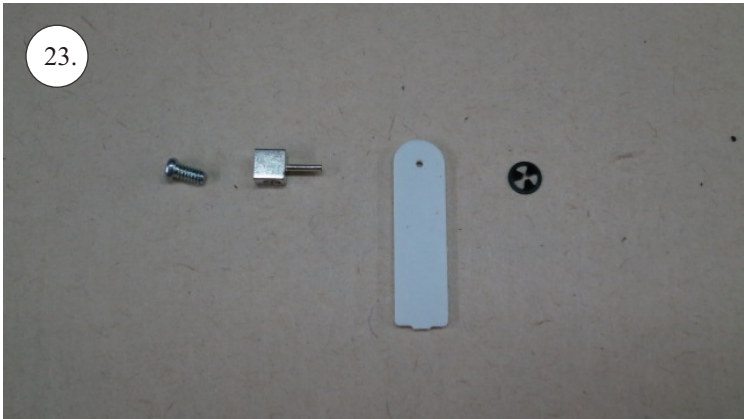
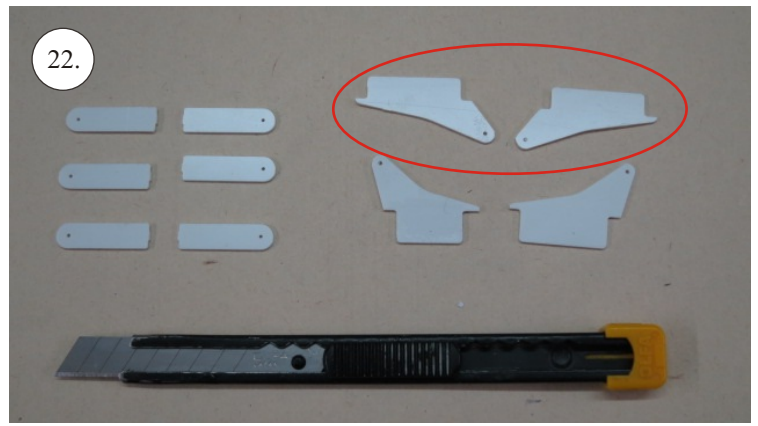
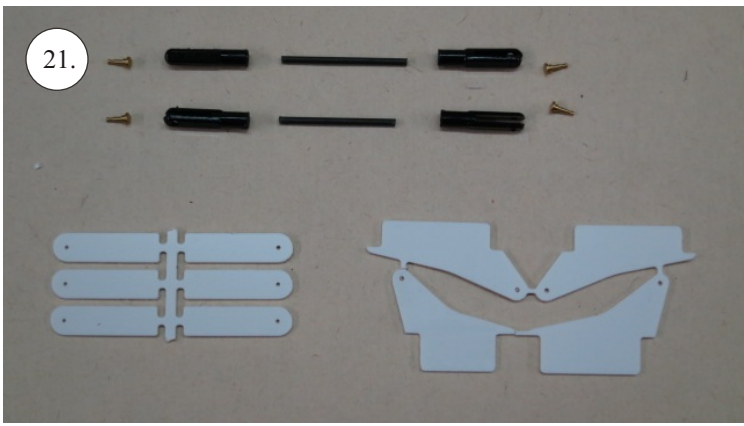

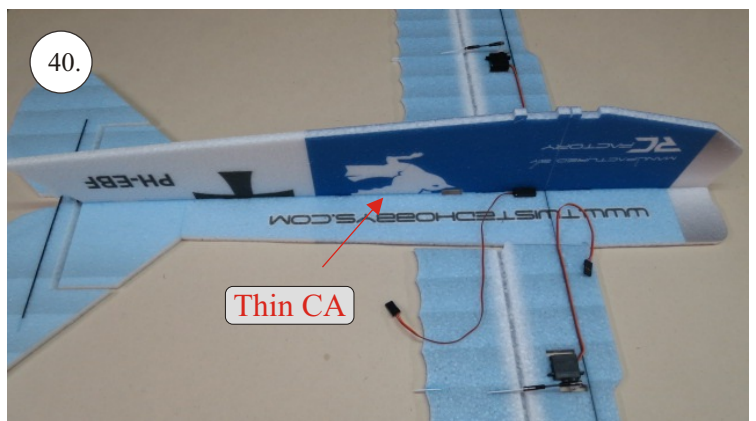
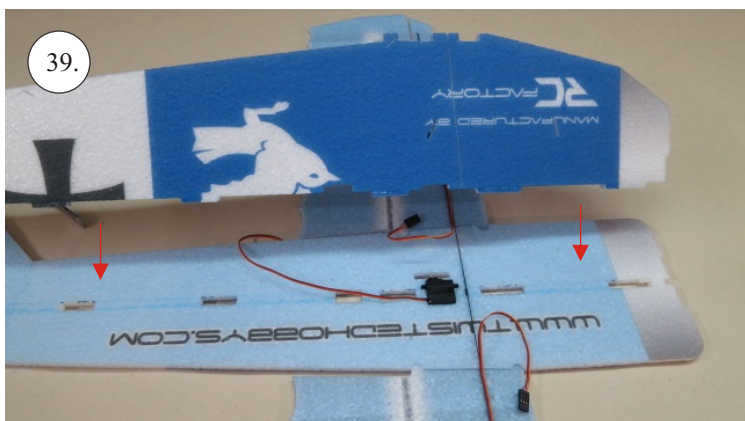
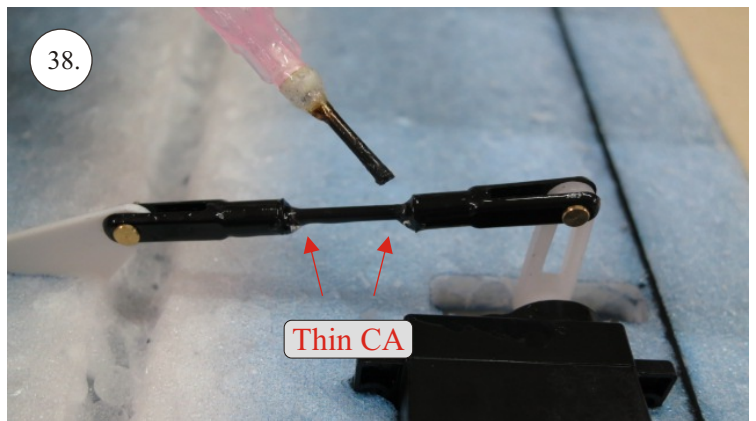
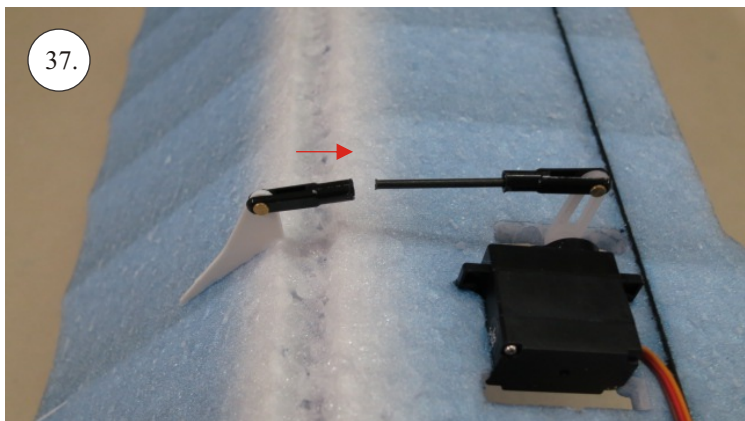
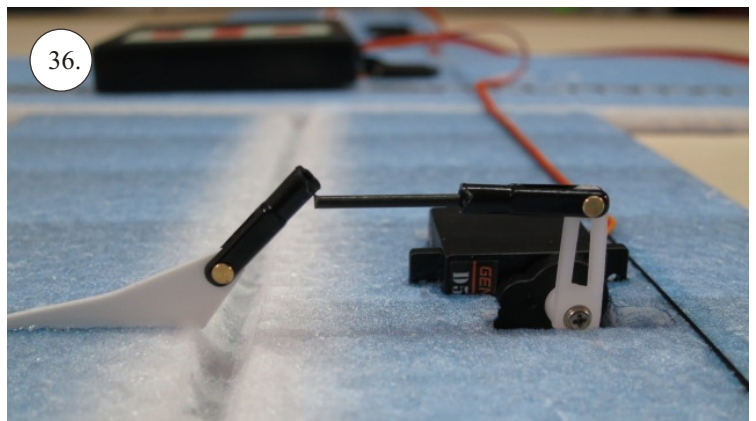
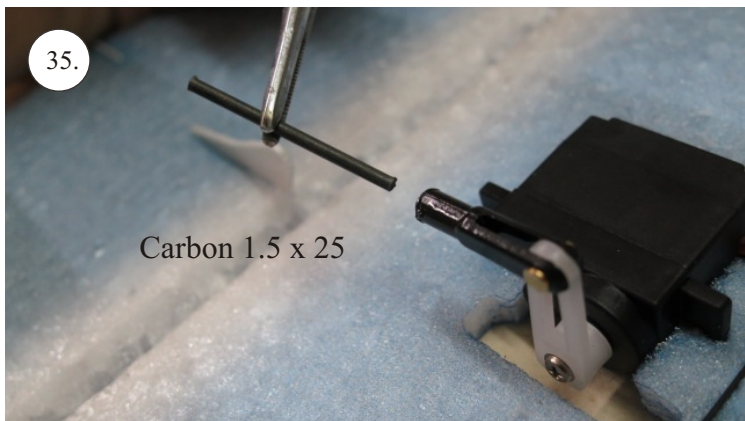
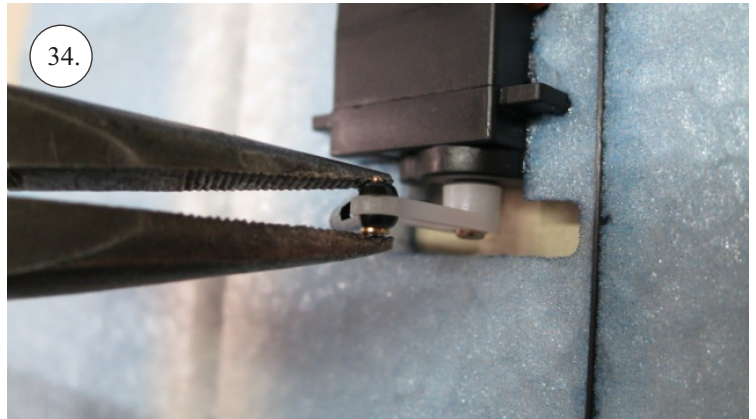
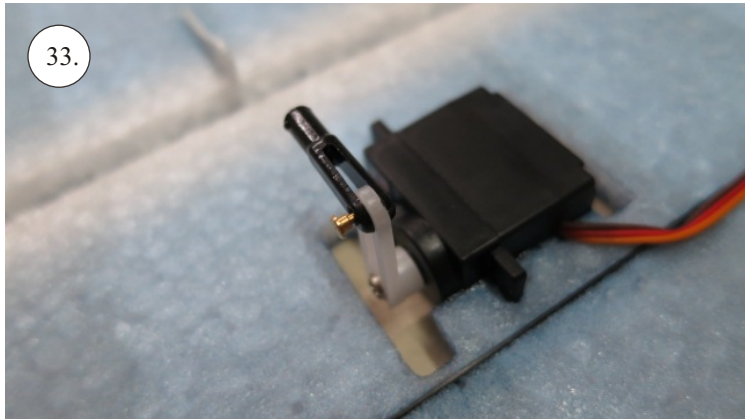
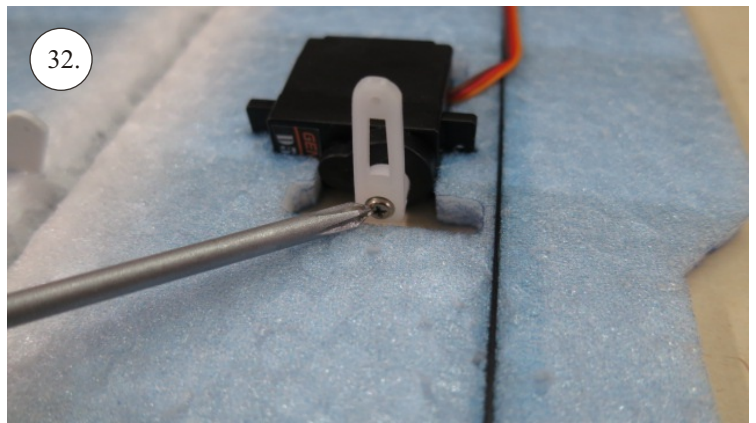
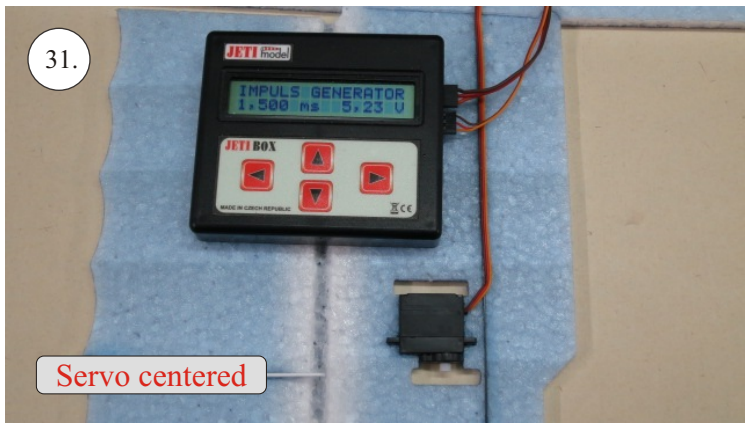

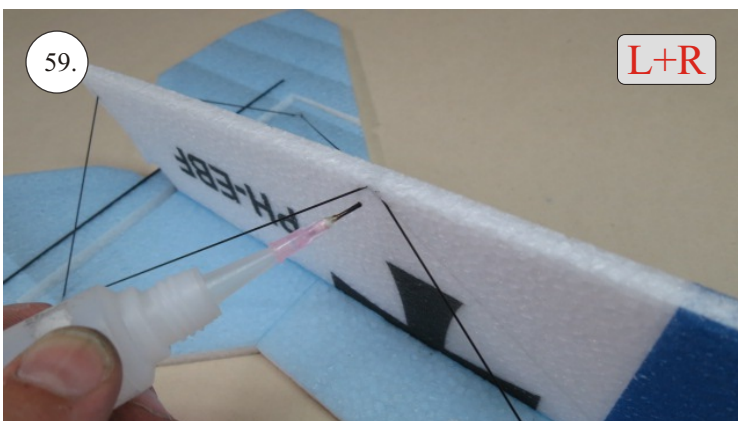
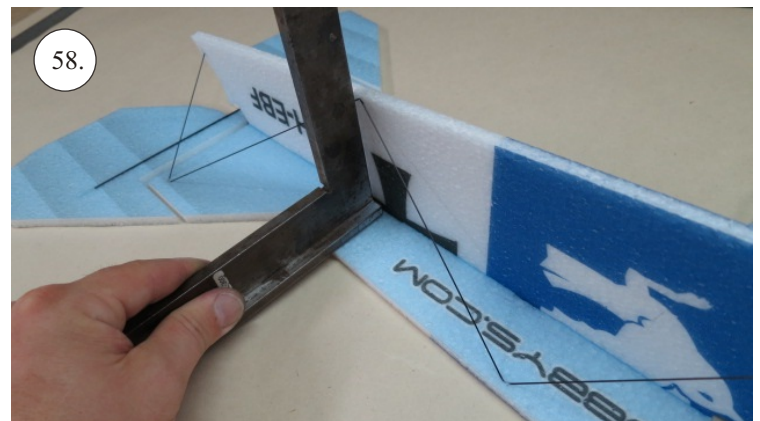
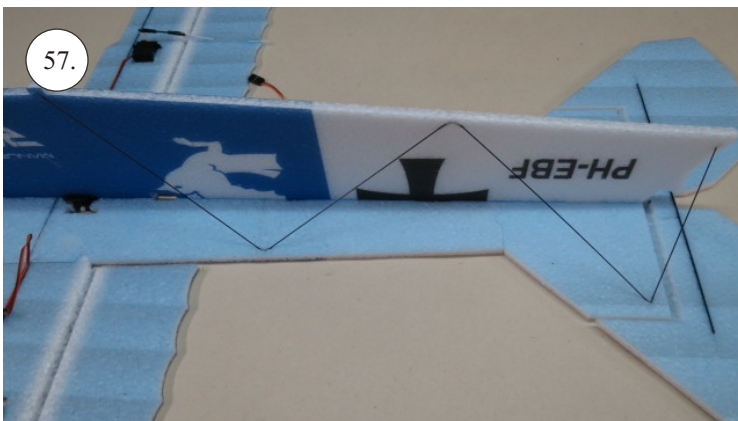
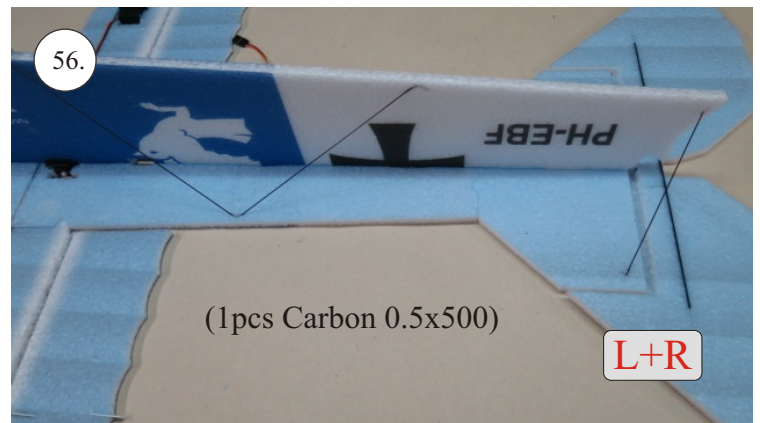
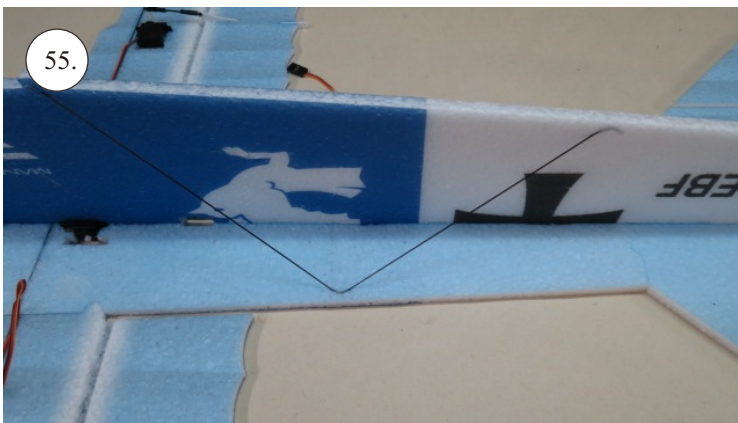
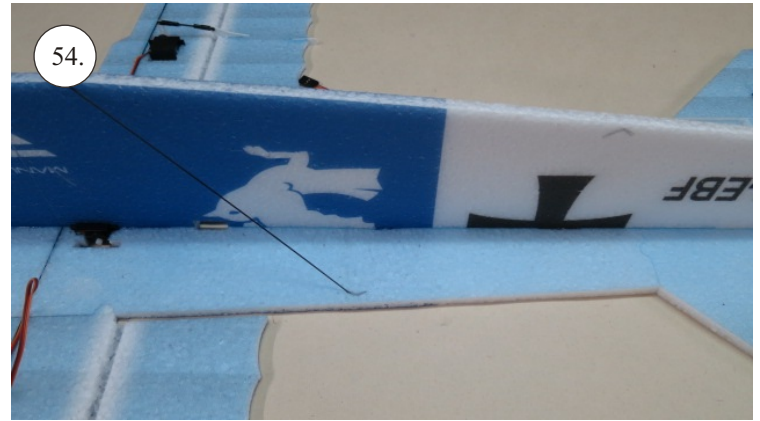
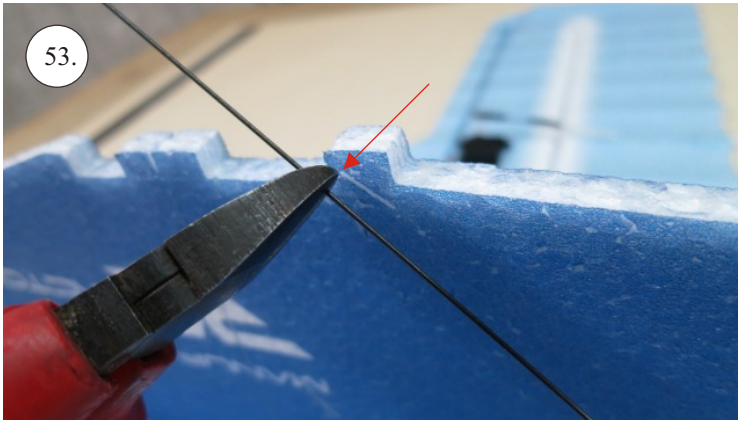
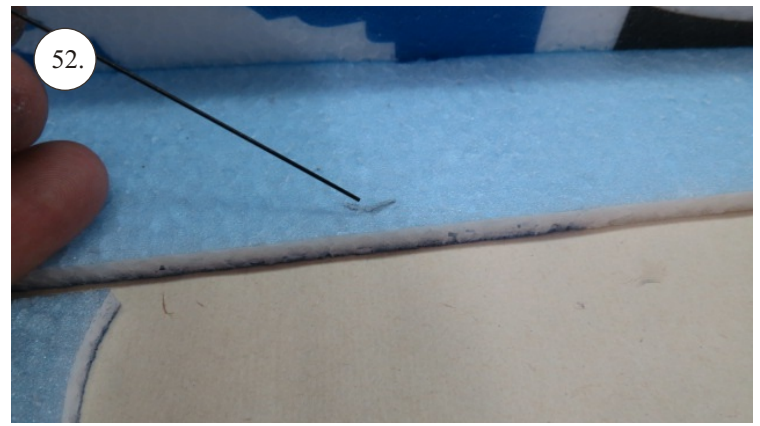
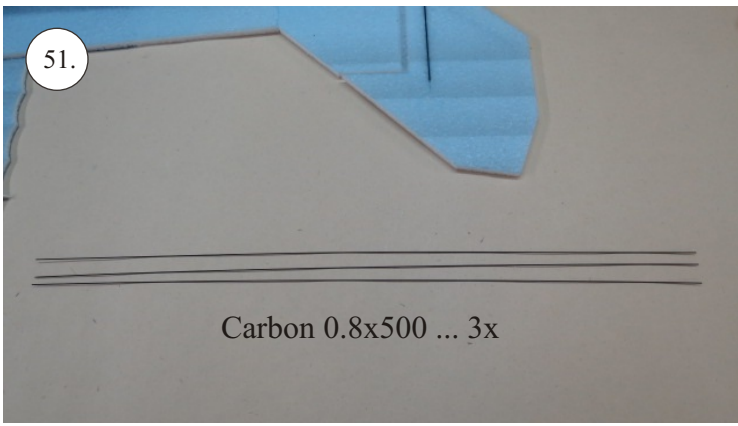

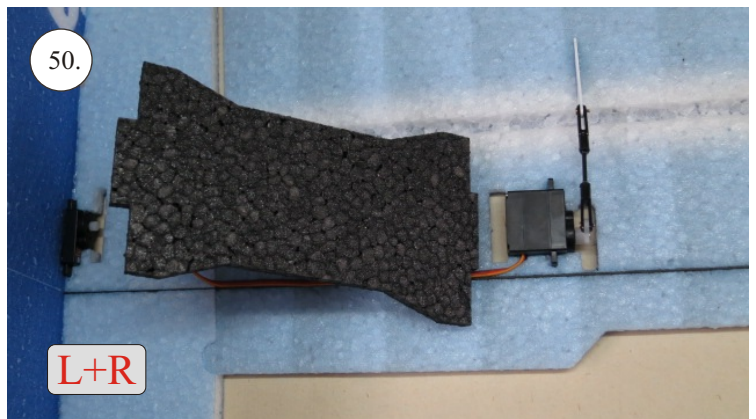
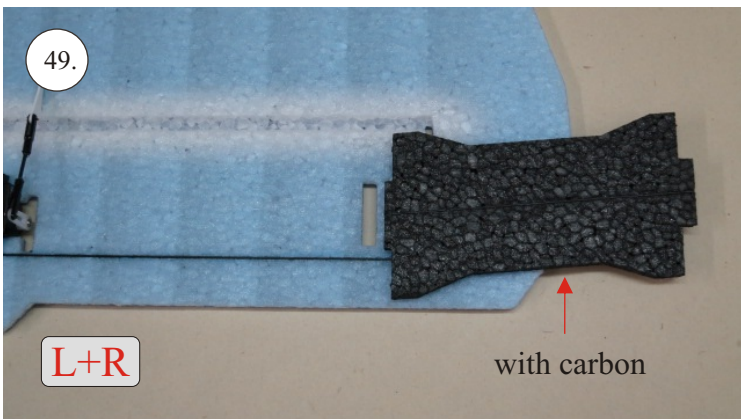
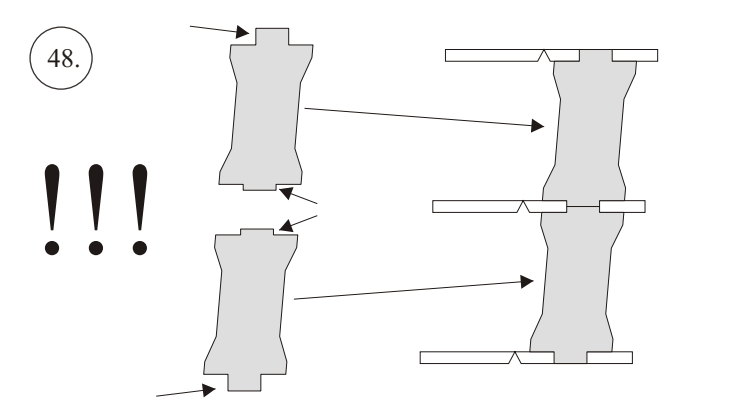
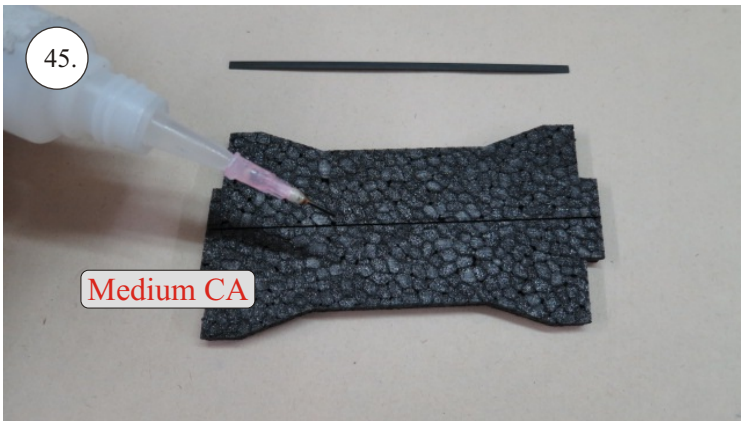
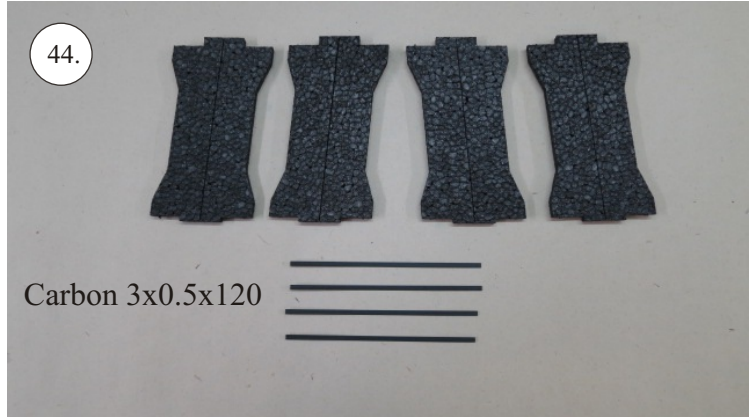
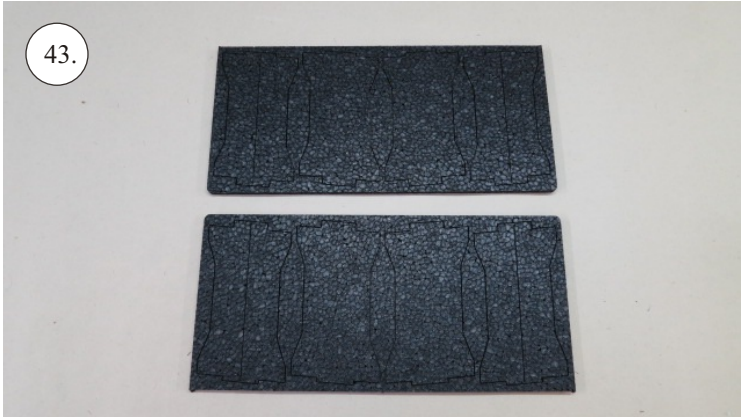
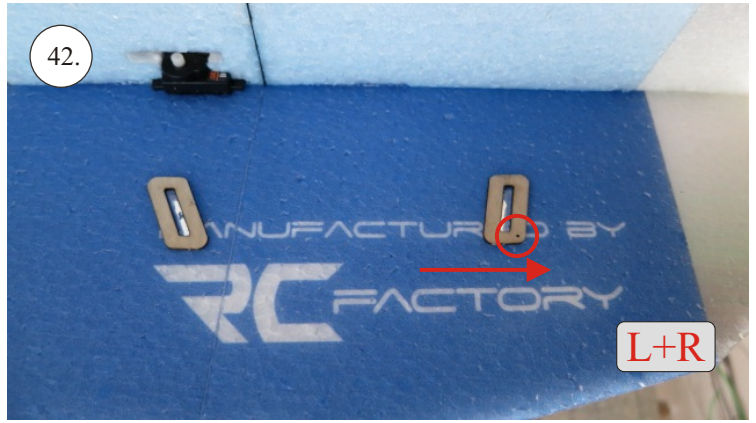
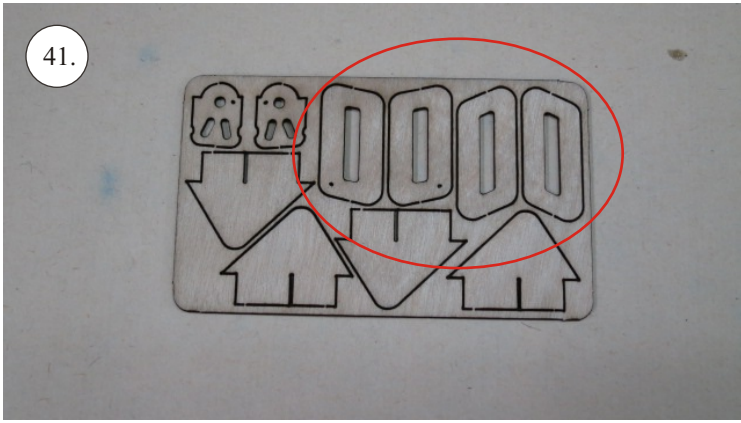

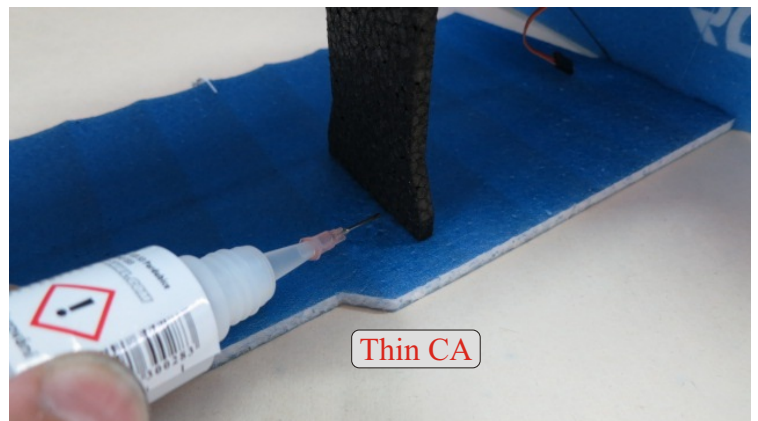
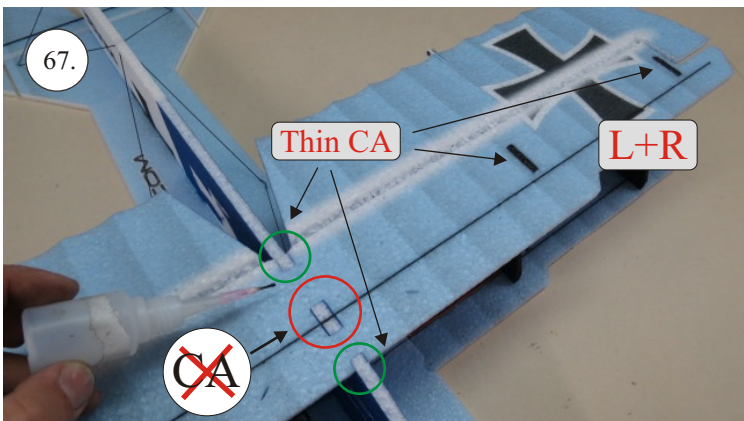
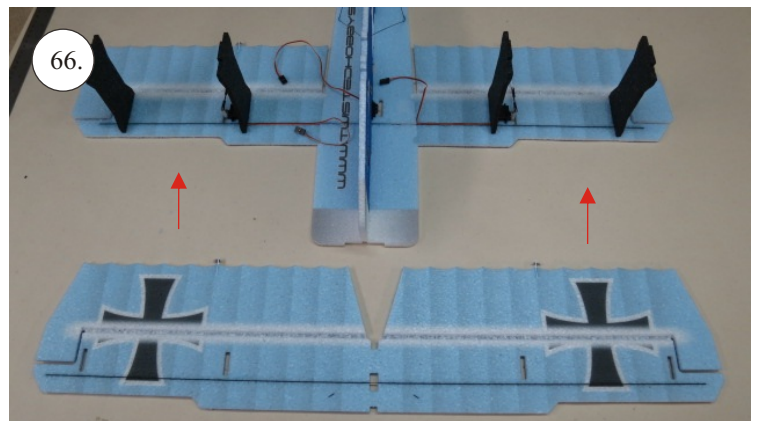
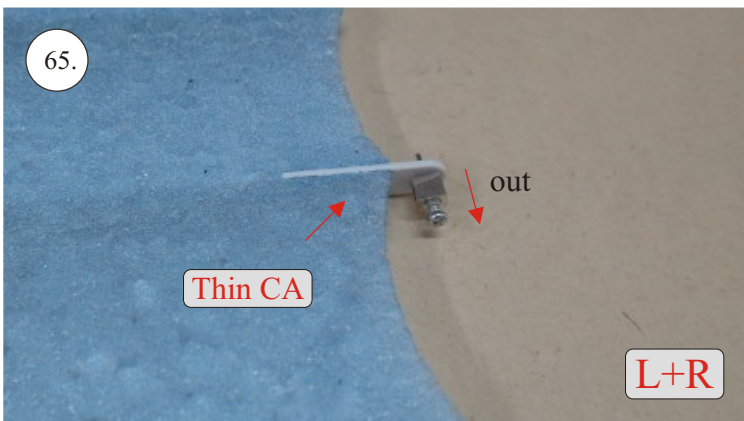
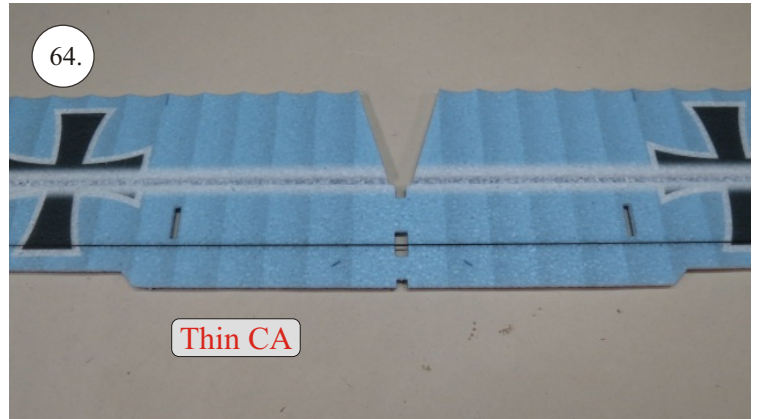
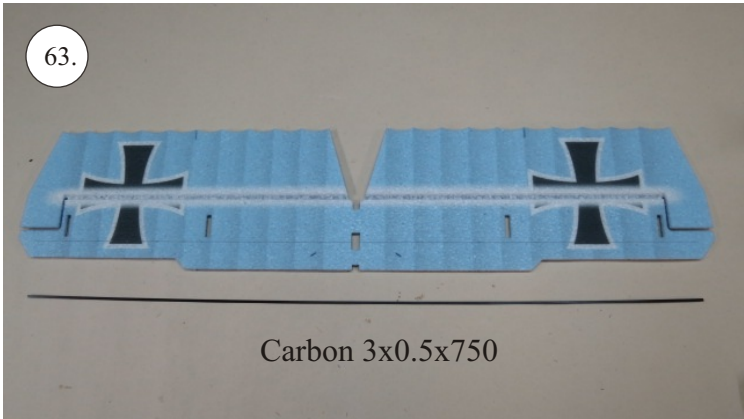
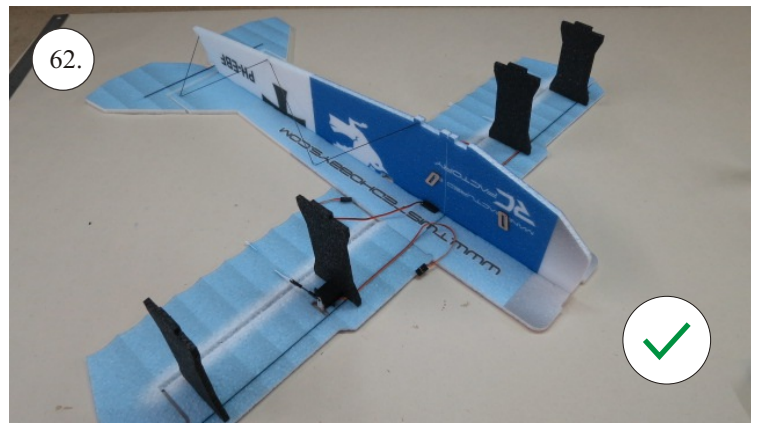
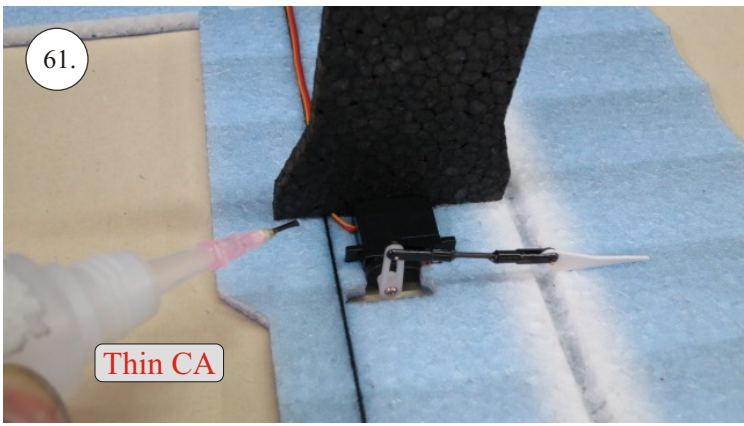



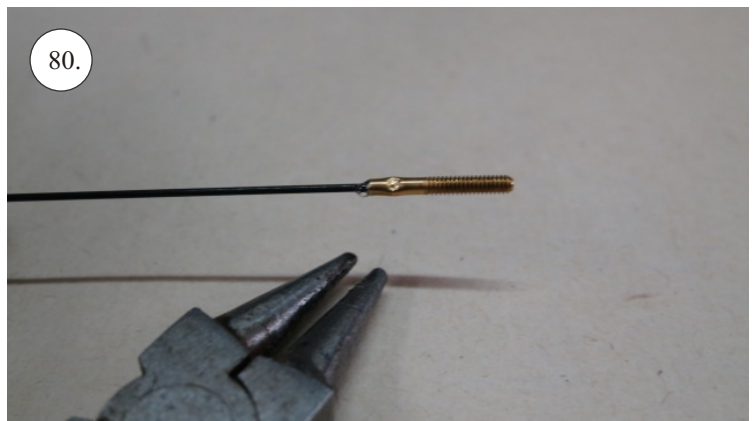
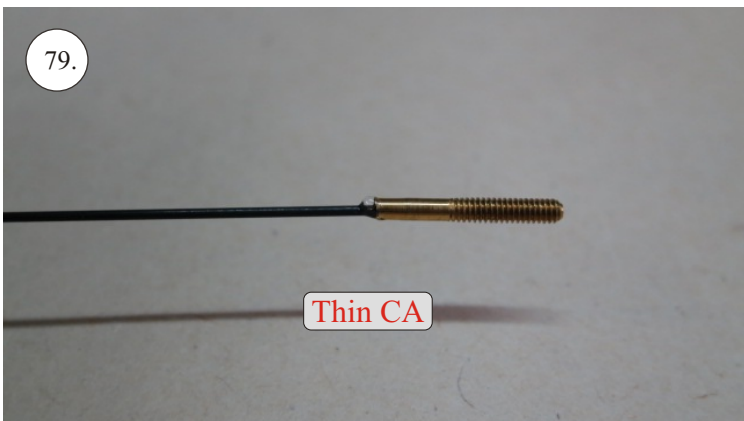
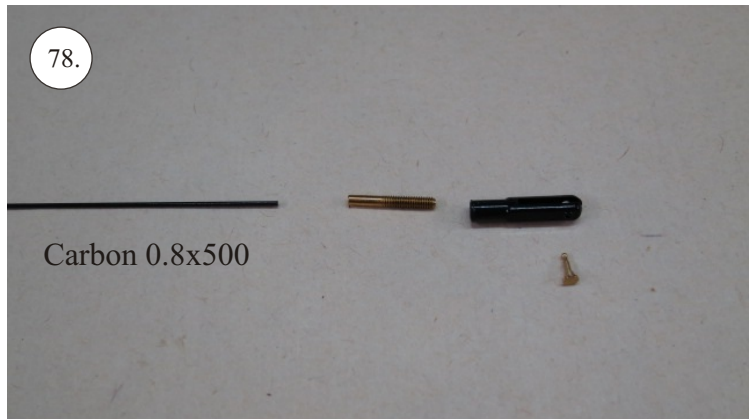
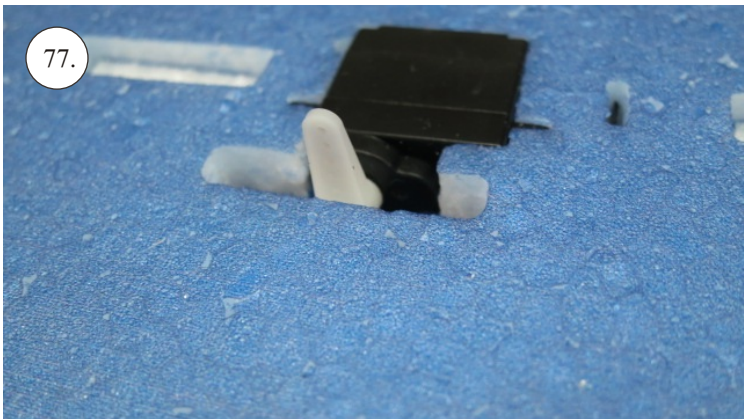
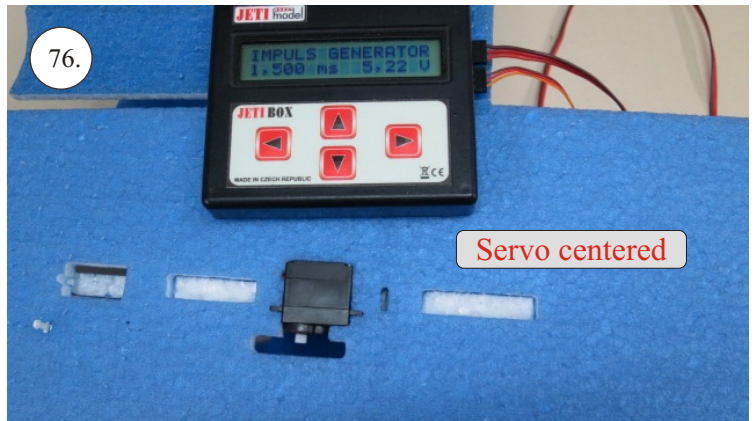
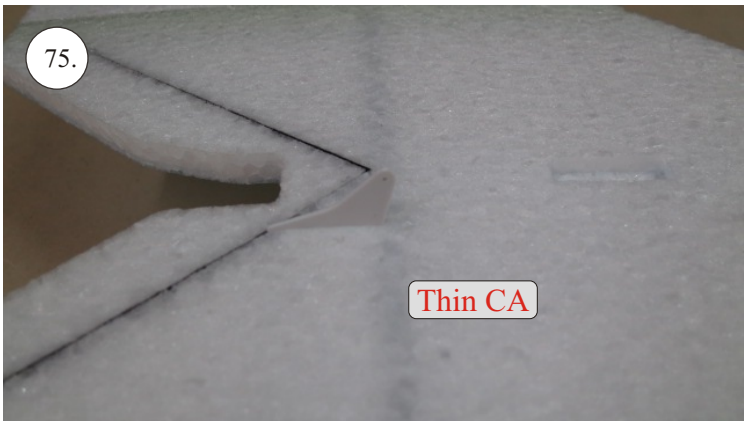
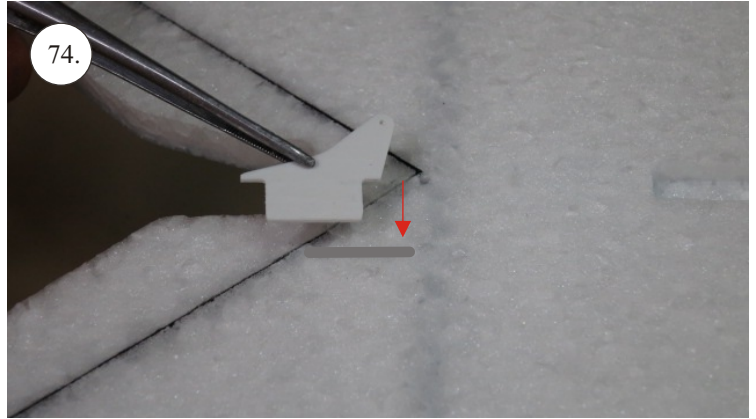
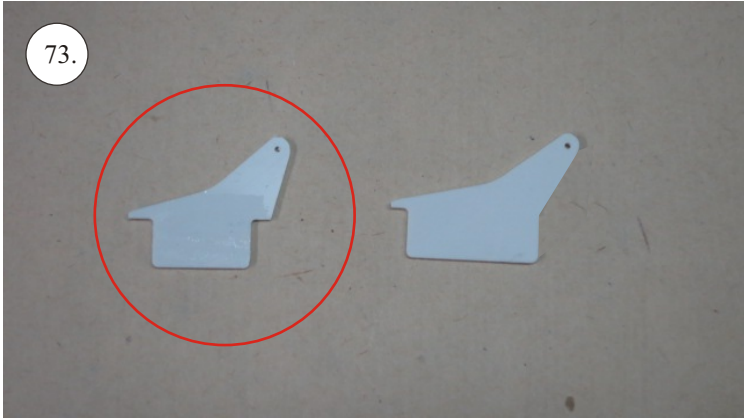
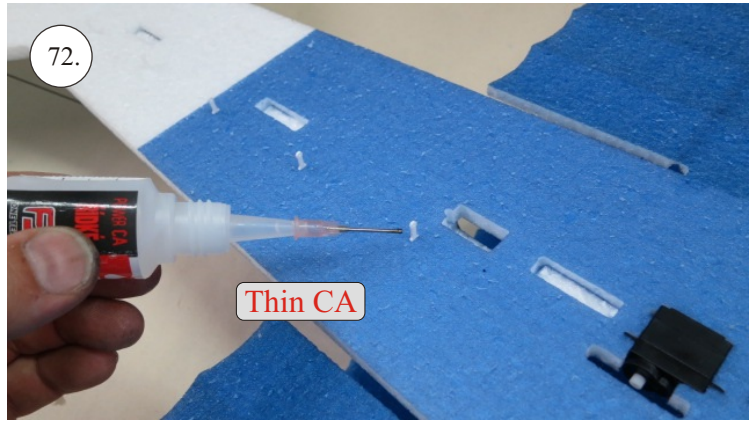
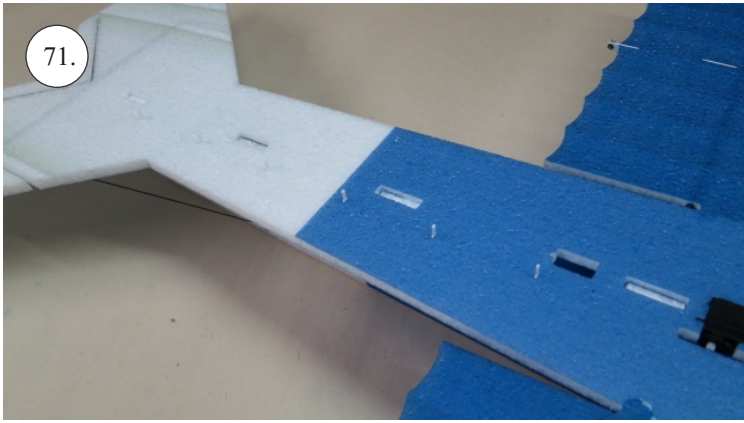

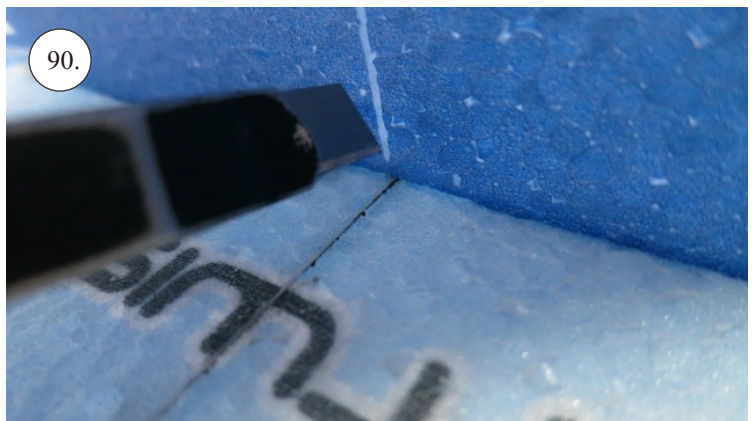
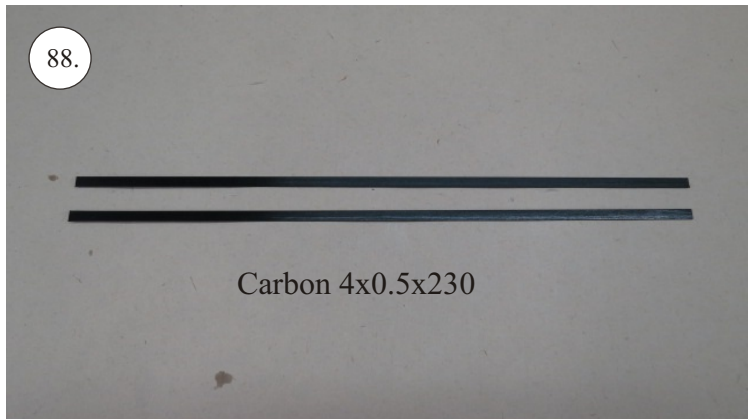
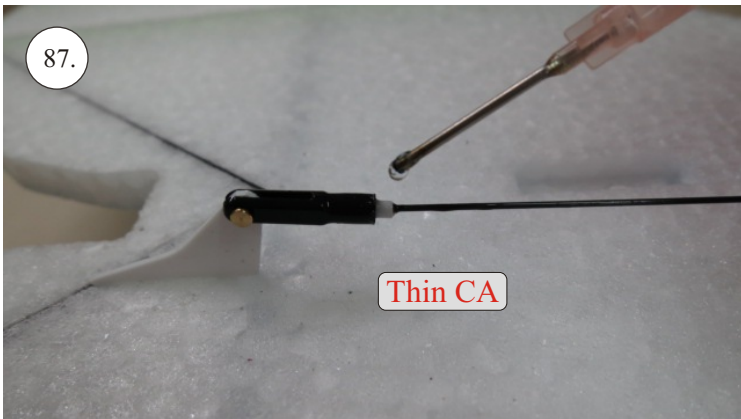
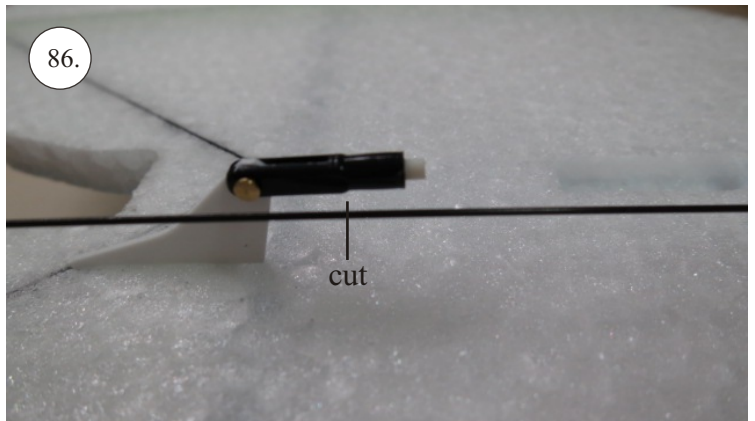
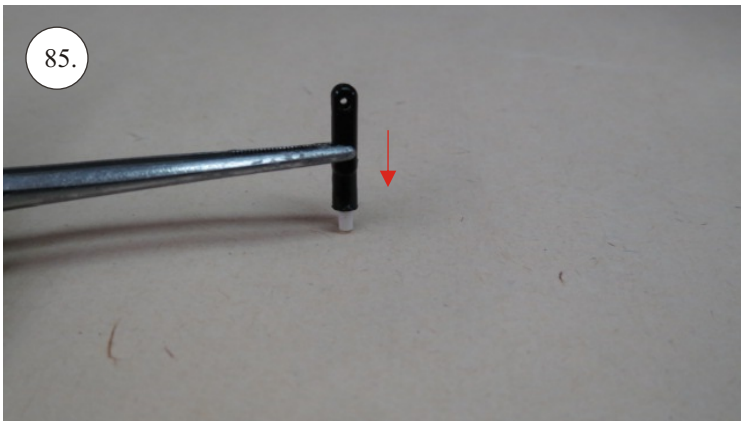
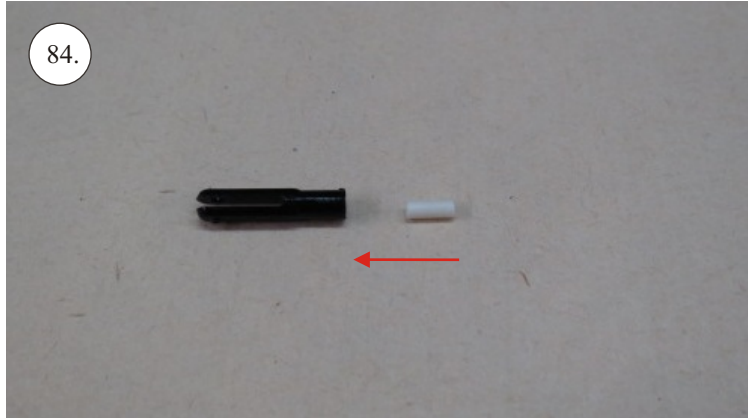
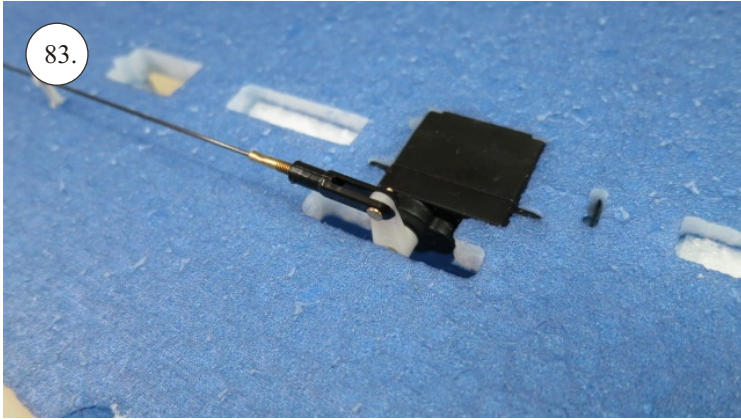
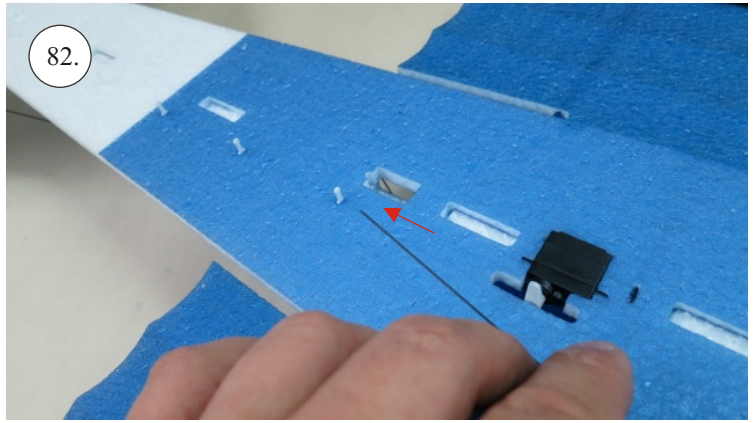

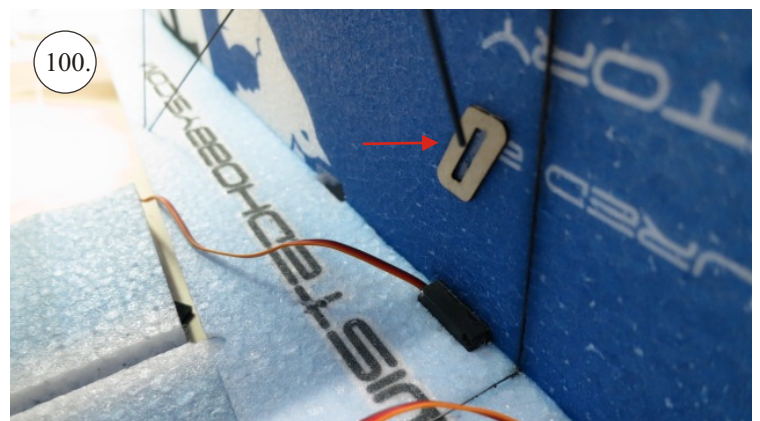
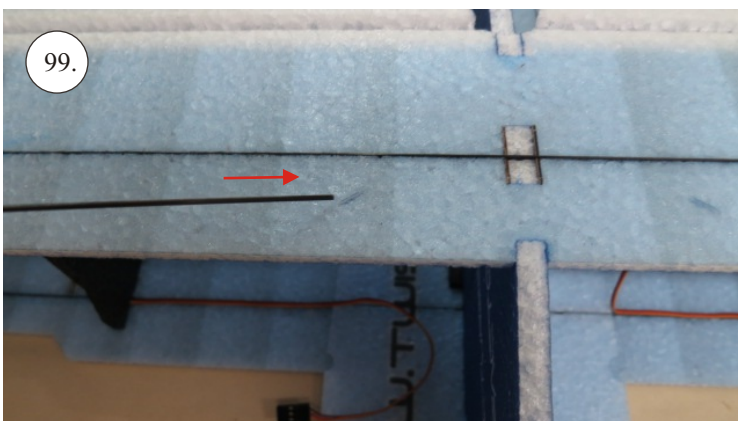
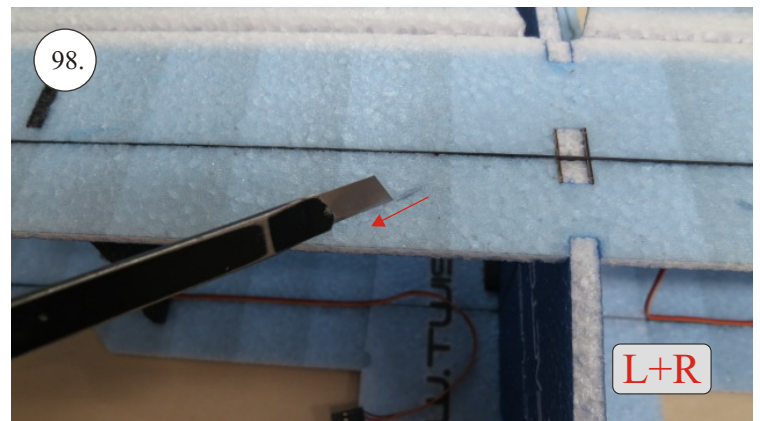
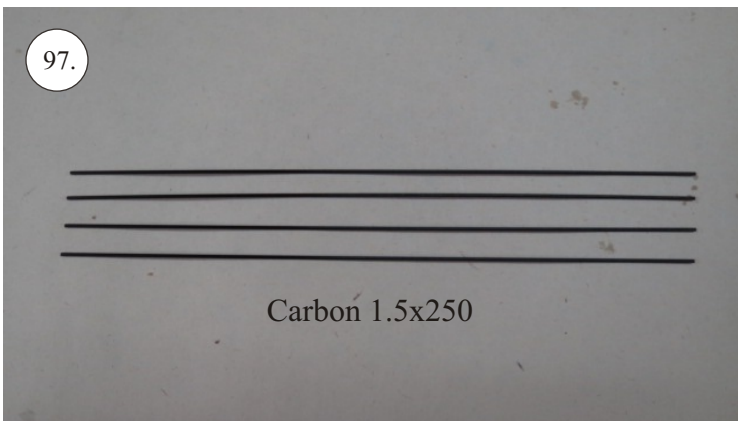
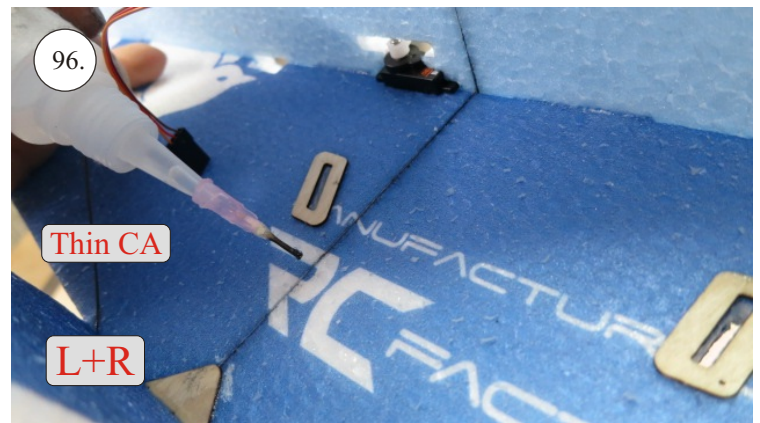
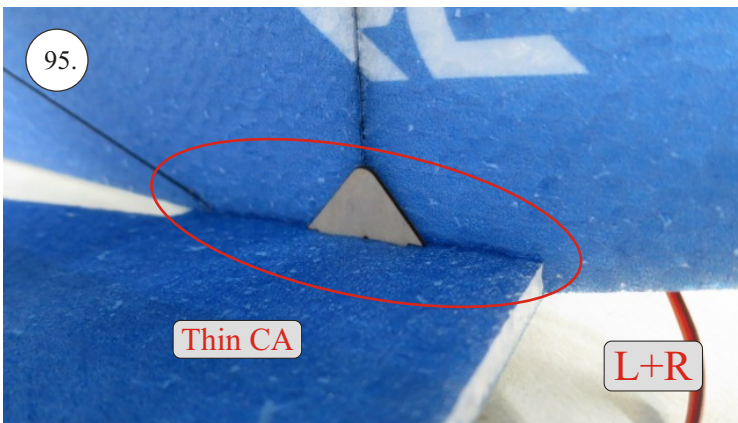
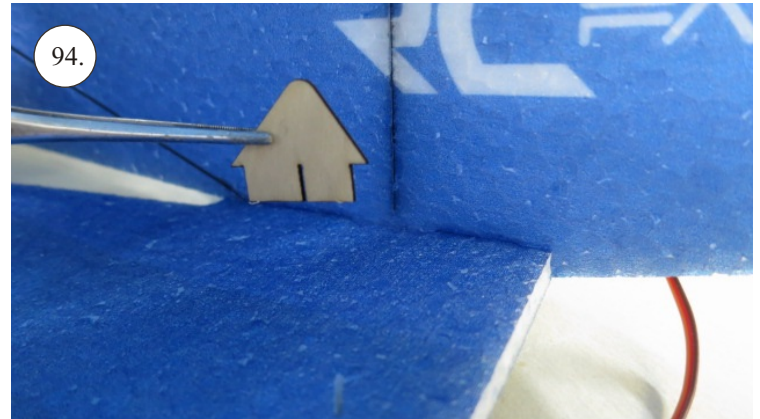
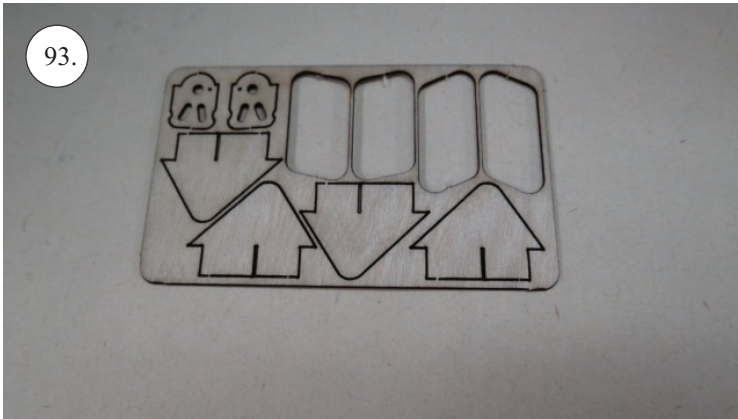
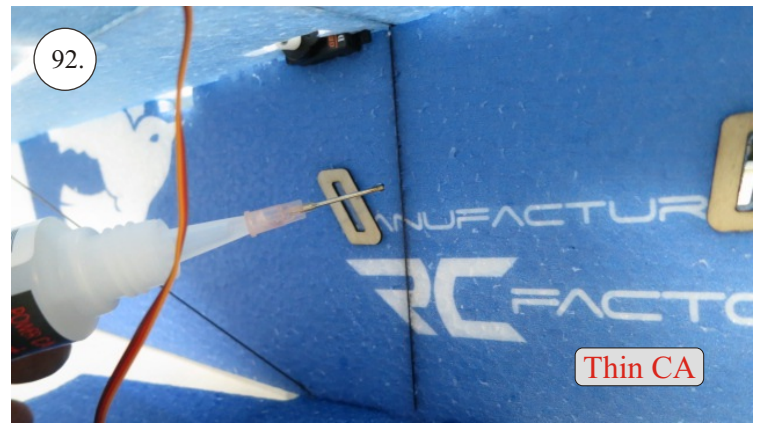
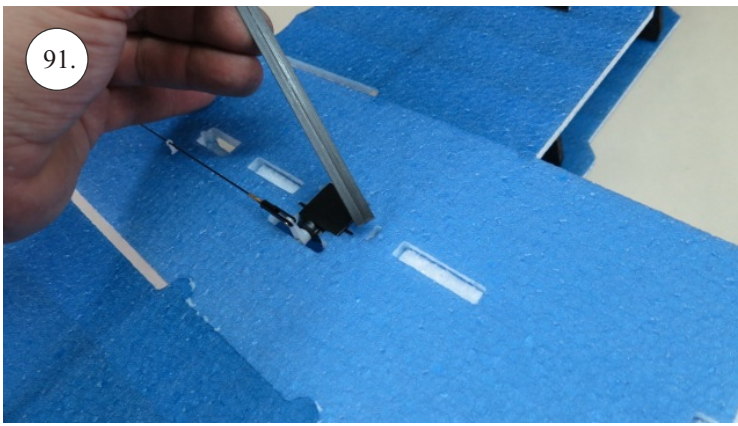

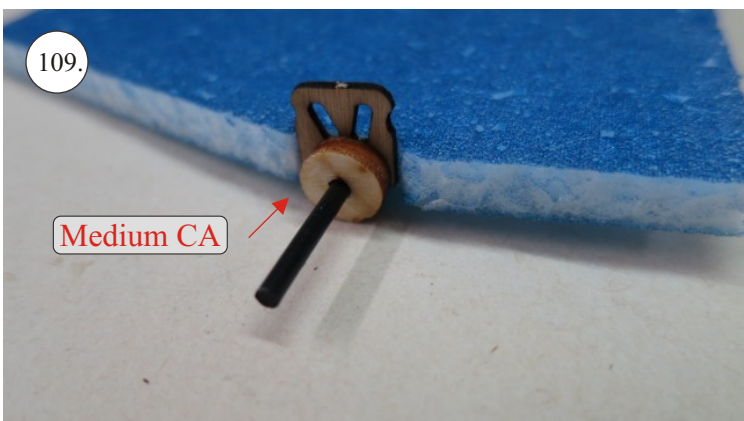
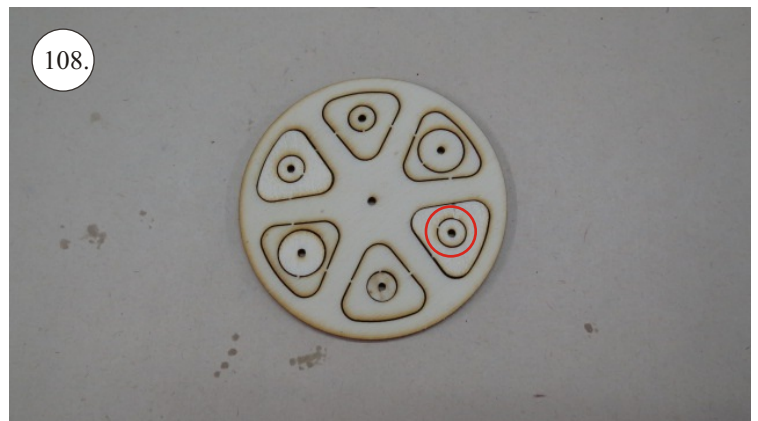
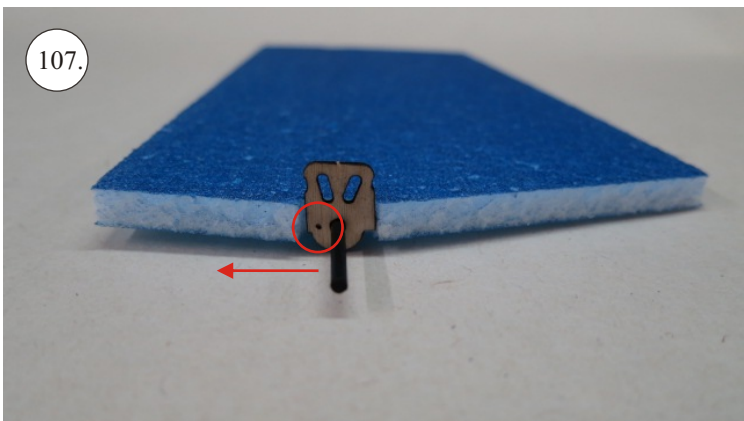
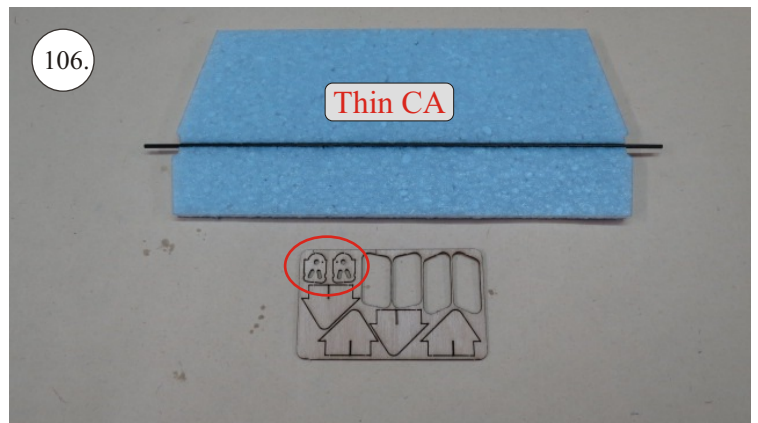
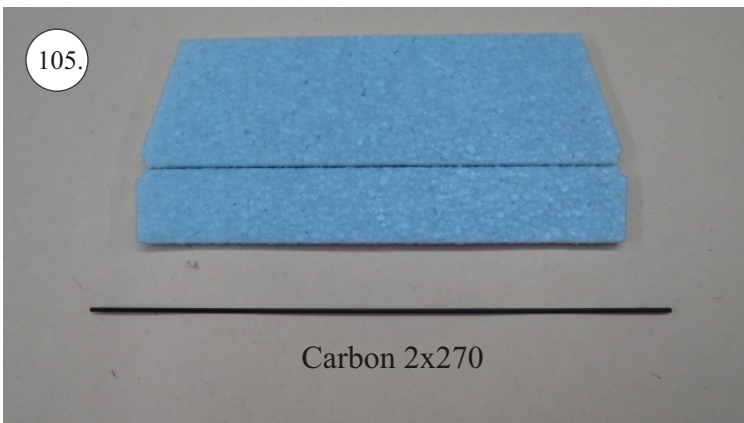
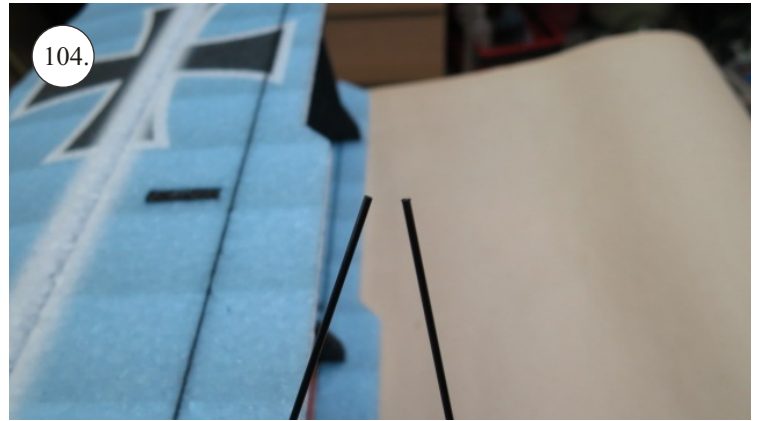
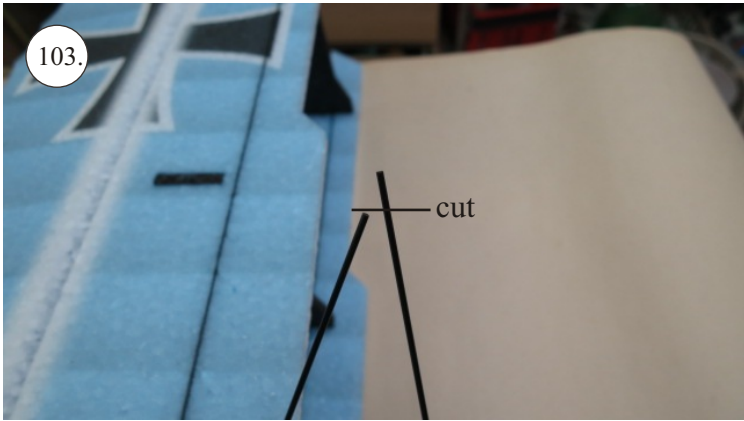
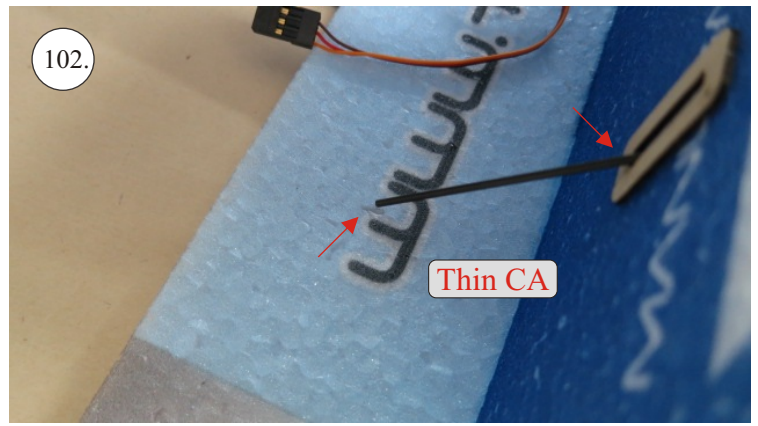
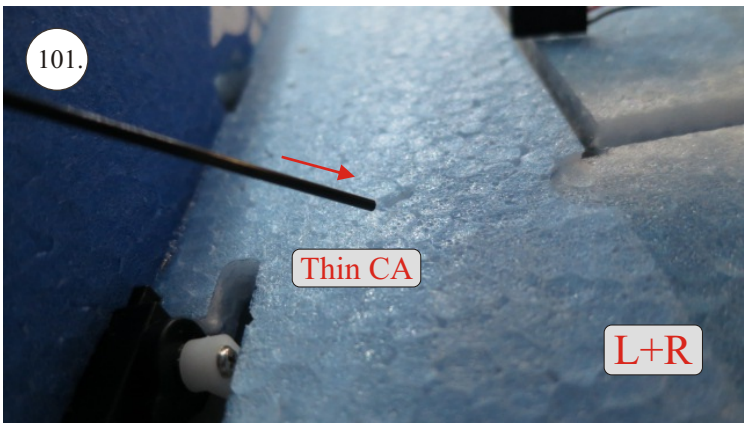

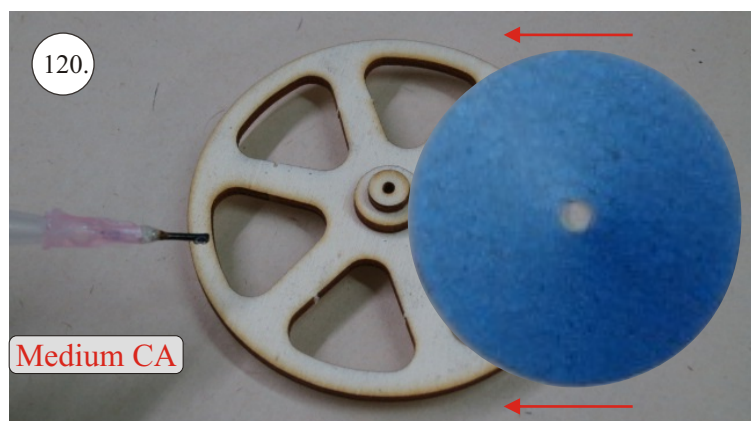
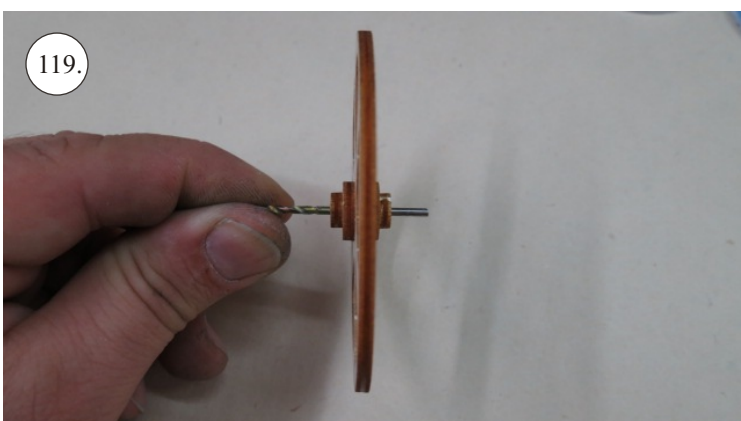
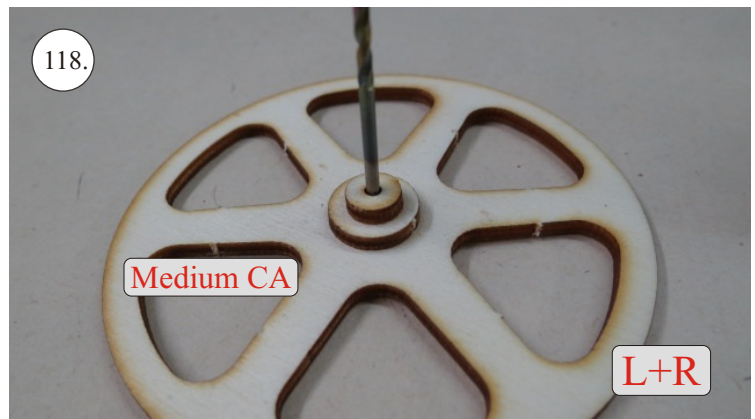
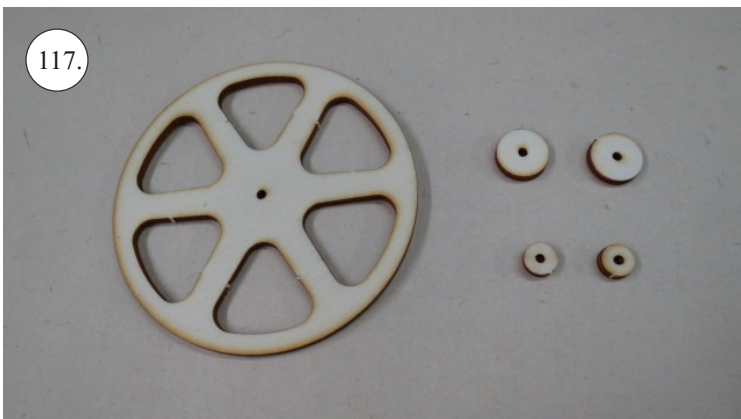
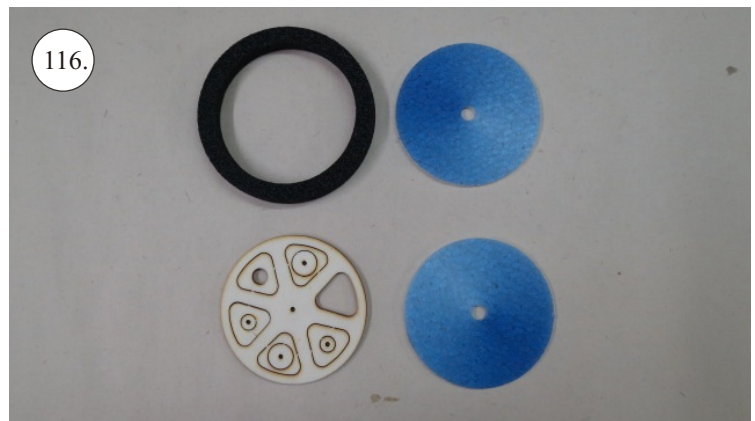
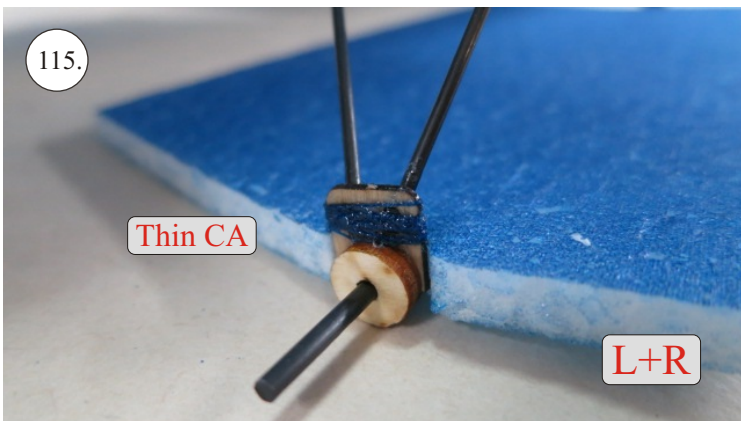
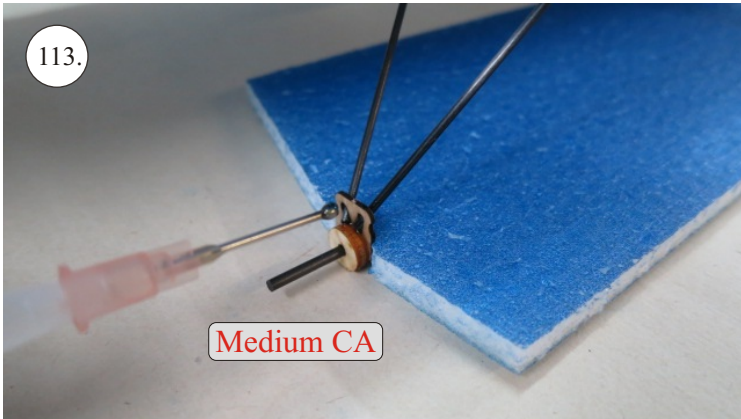
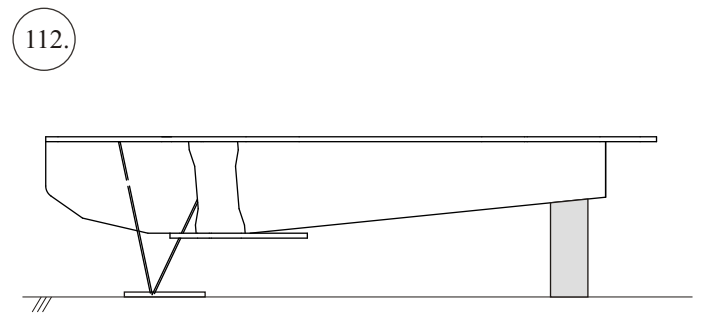
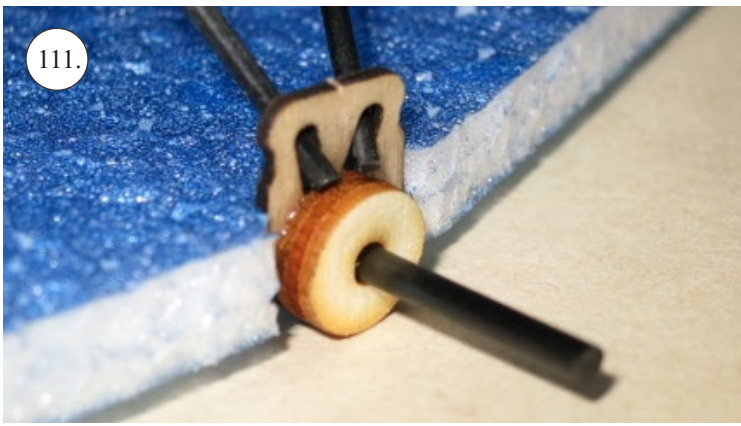

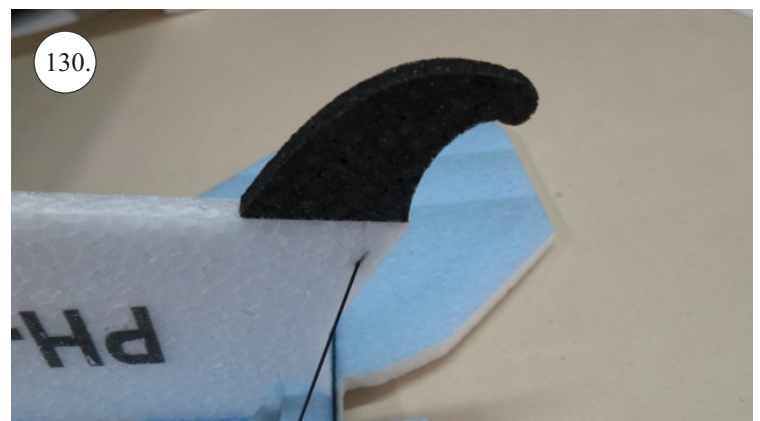
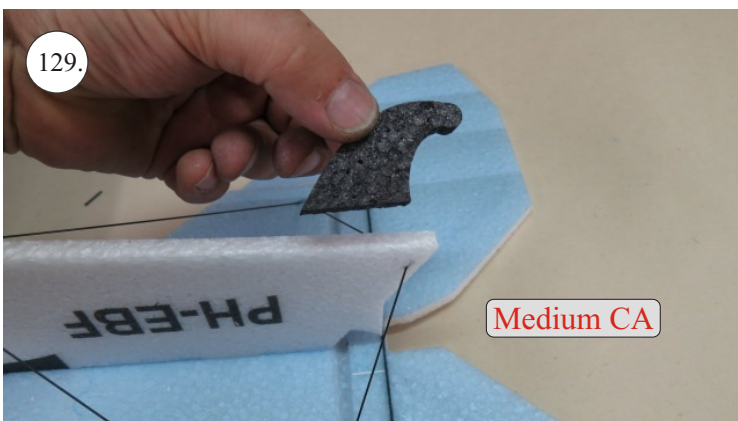
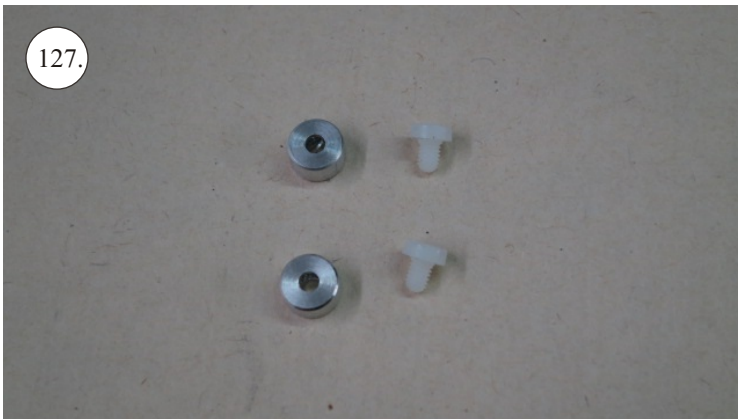
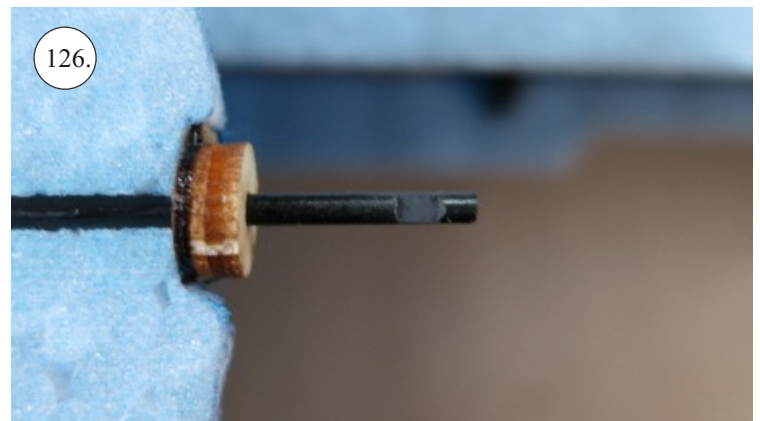
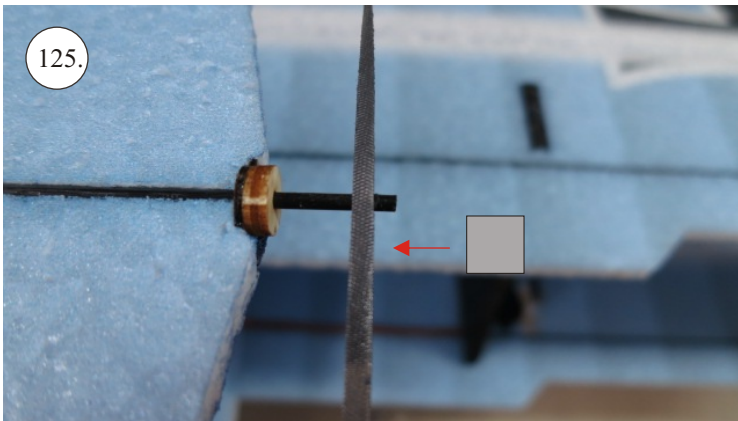
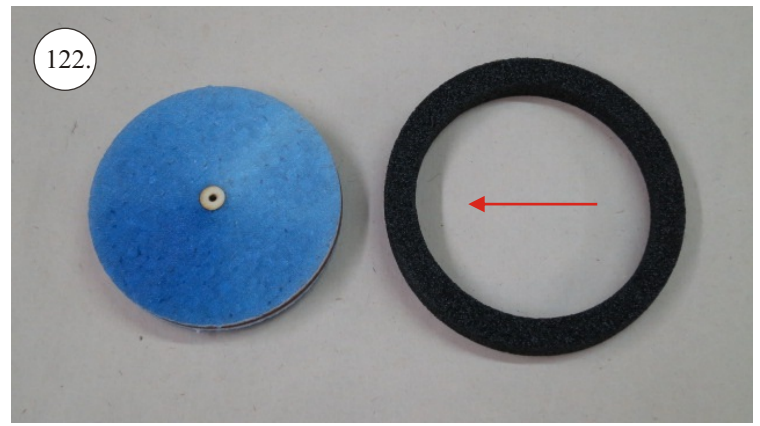
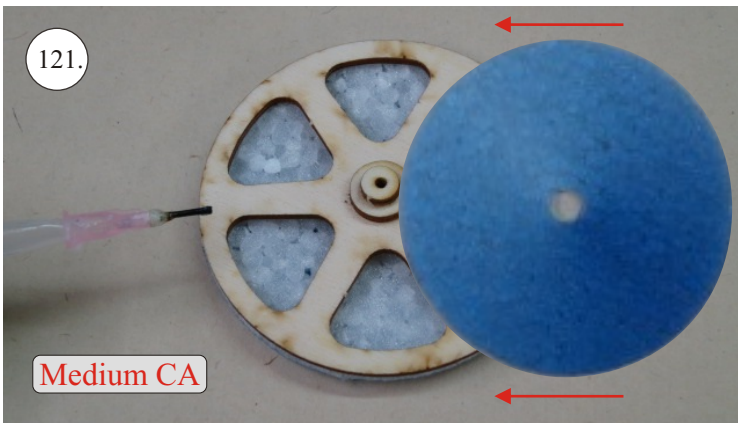

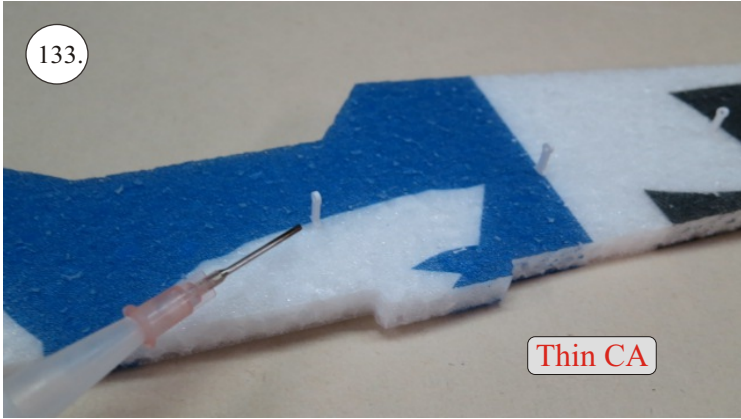
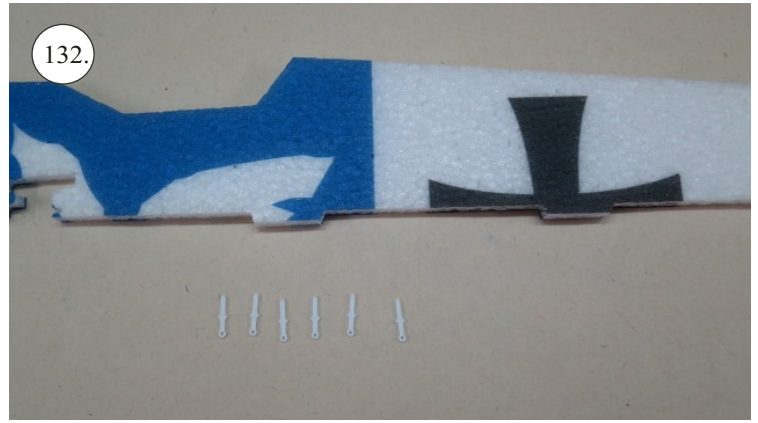
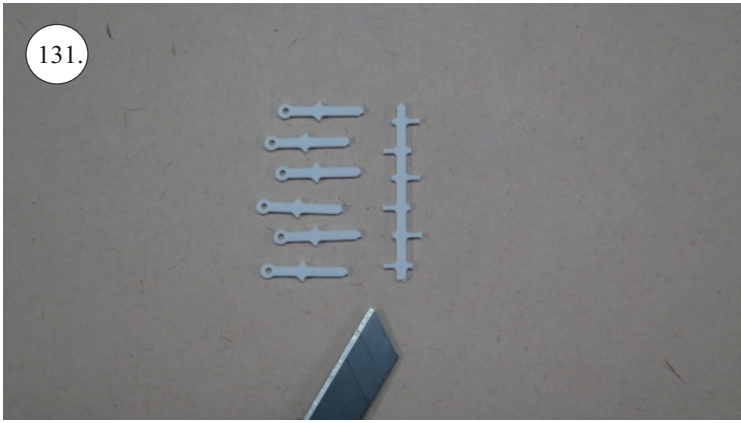

Thin CA



Servo centered

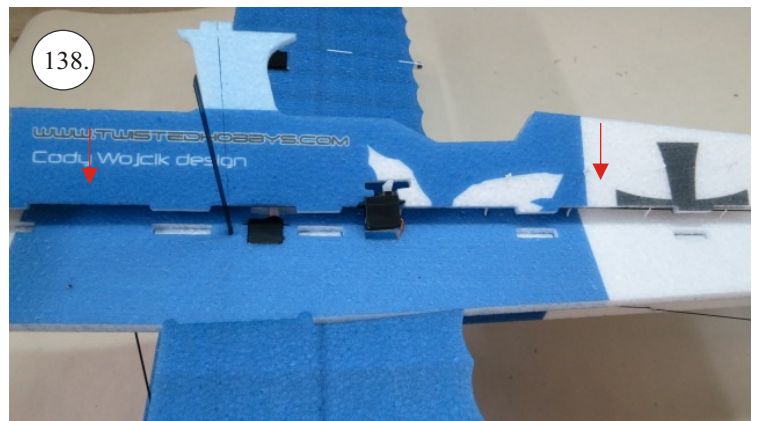
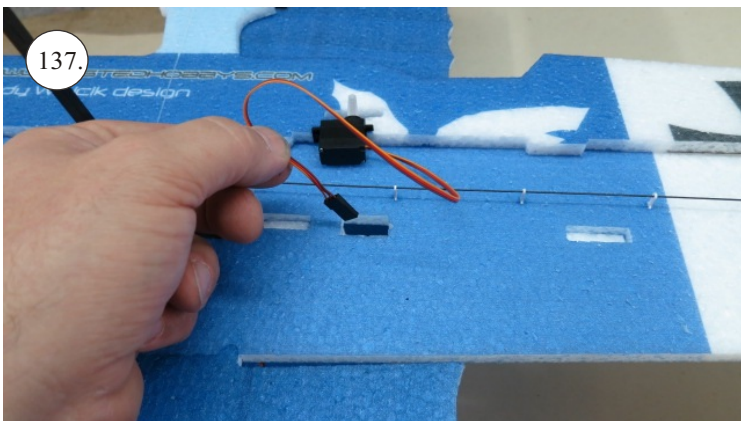
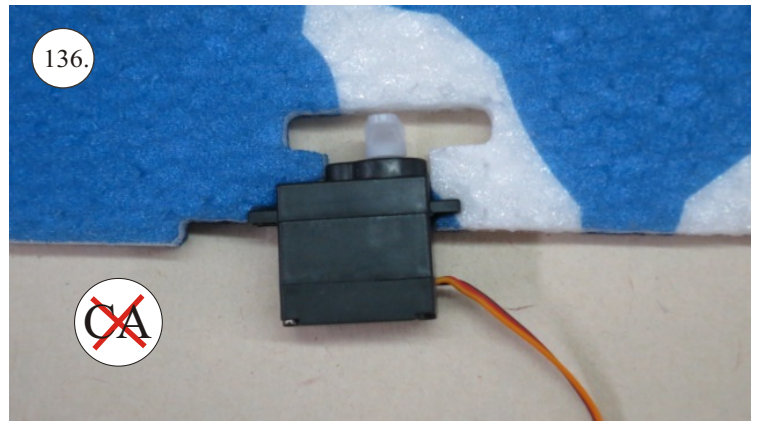

Thin CA

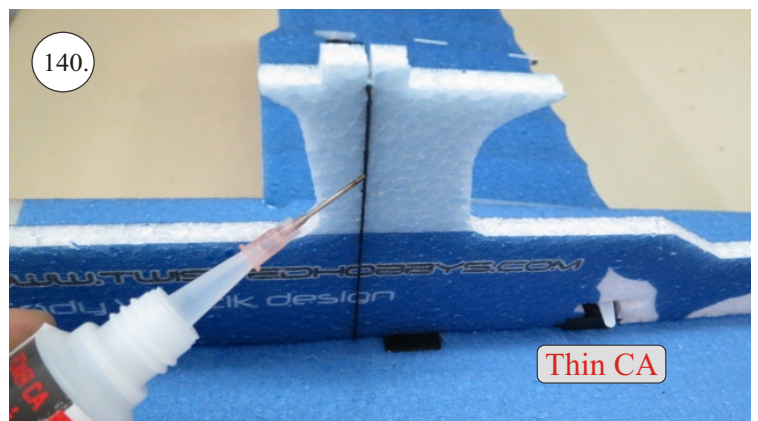

Thin CA

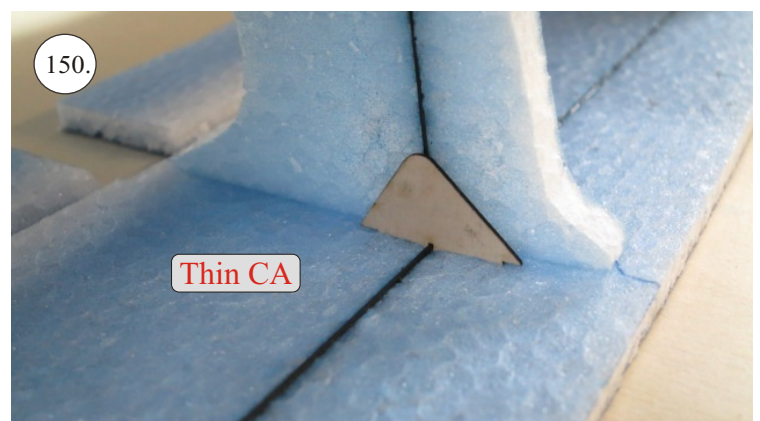
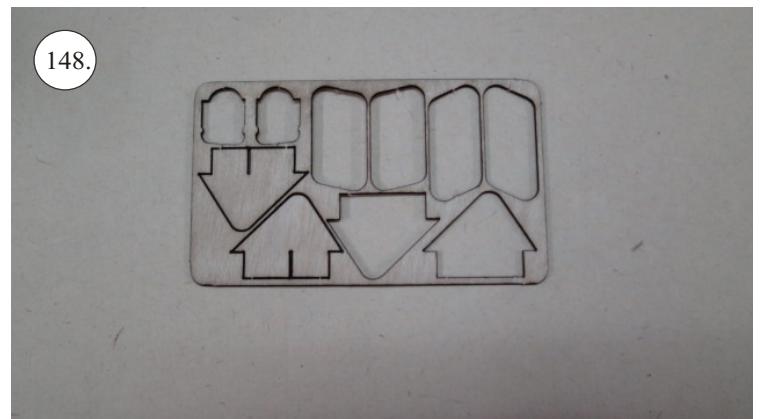
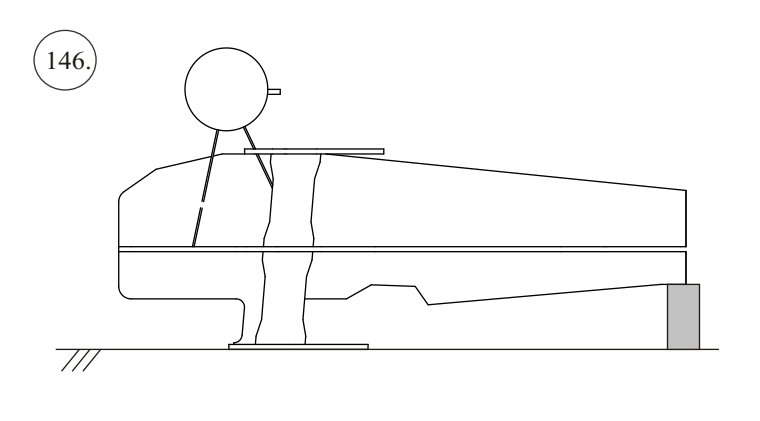
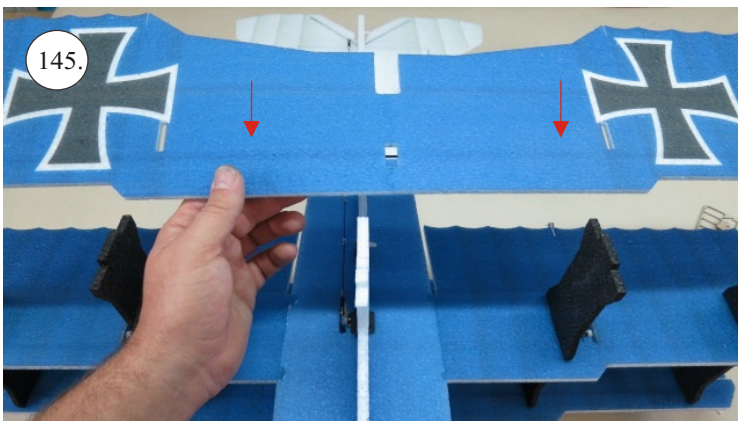
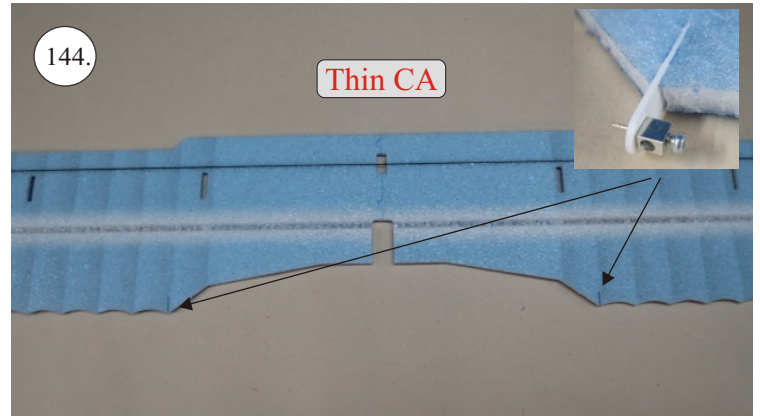
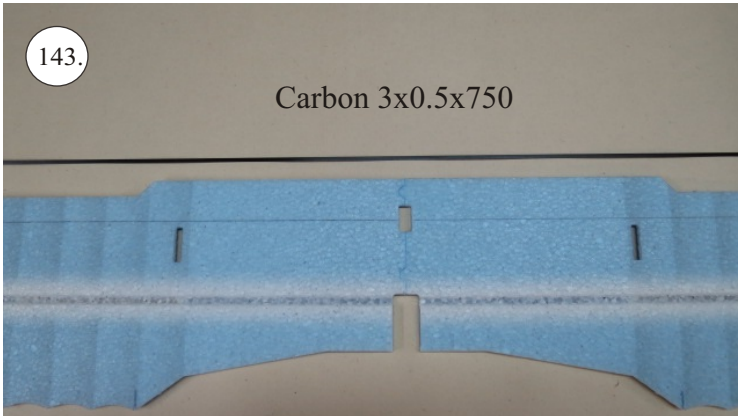
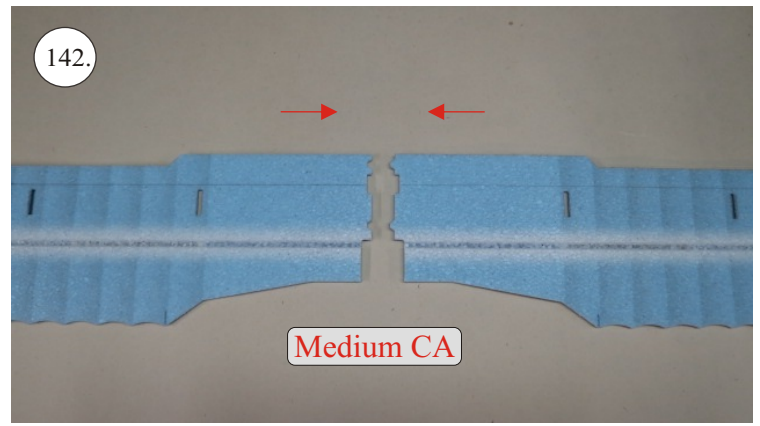
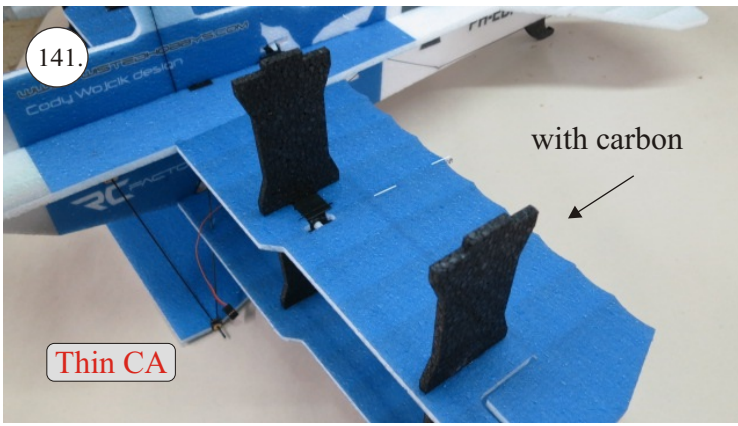



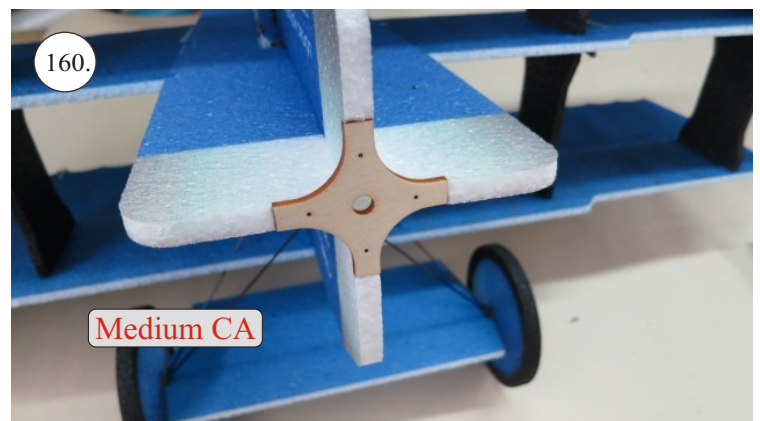
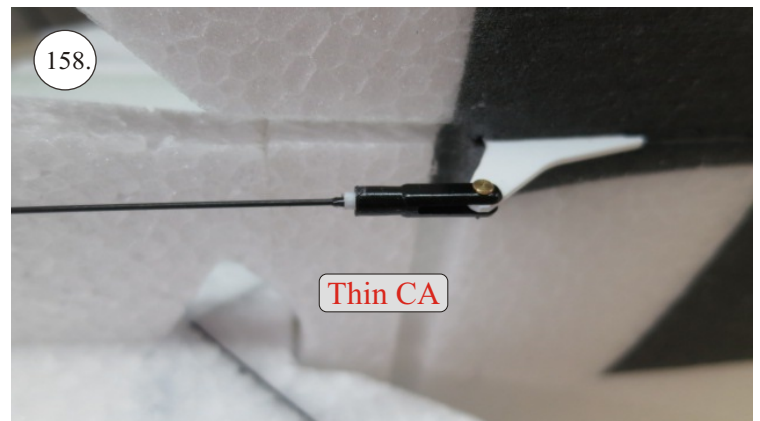
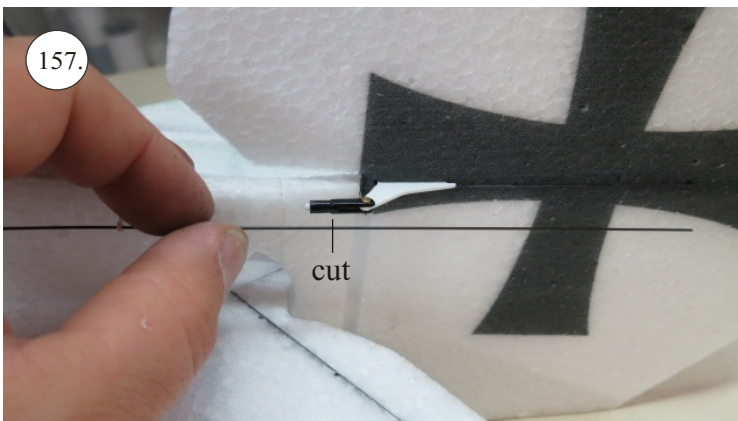
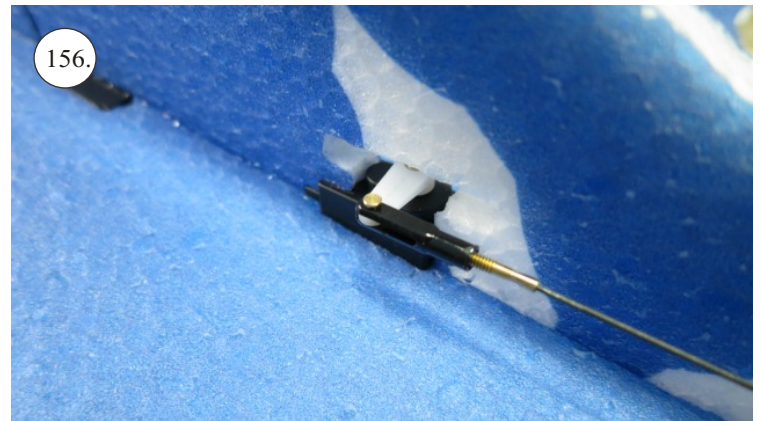
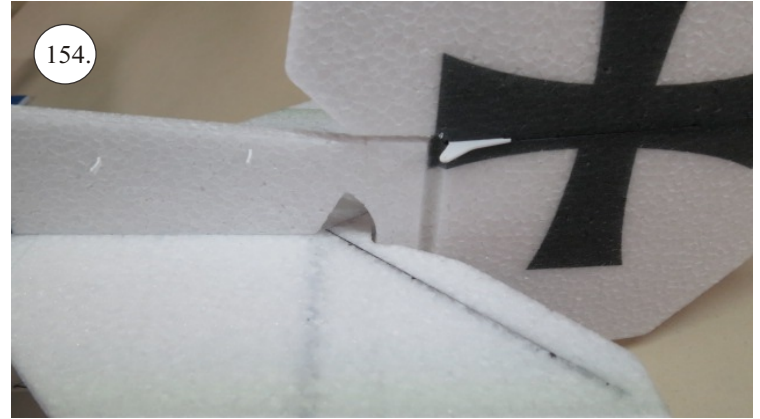
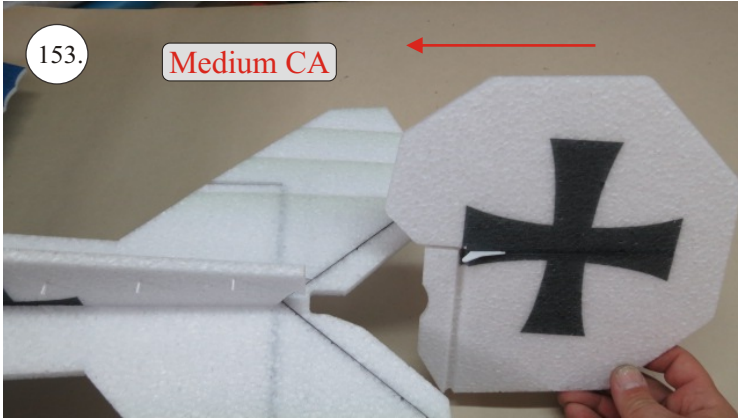
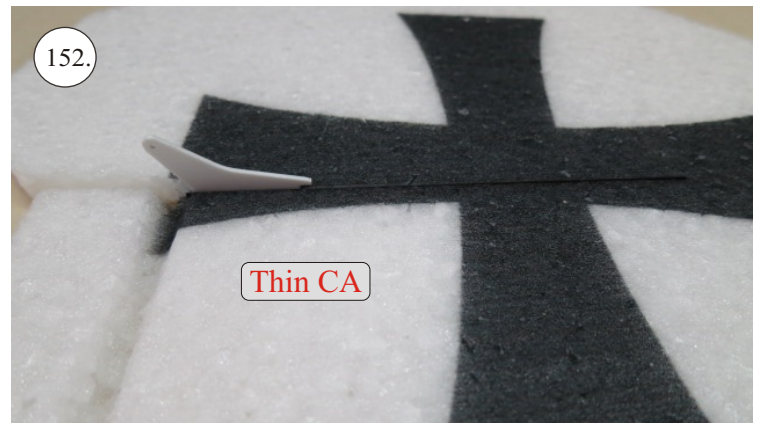
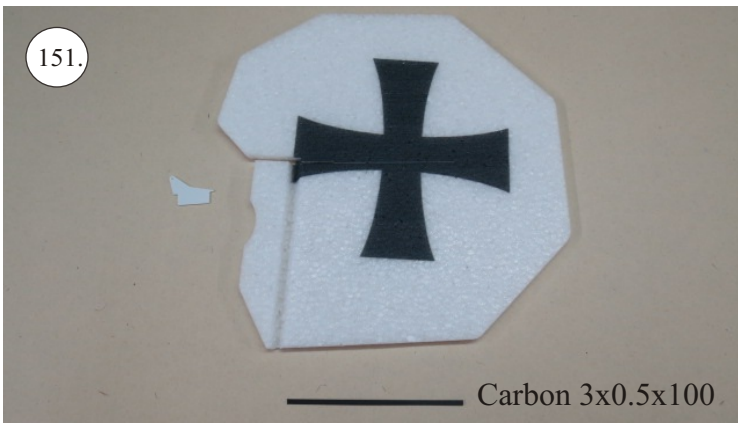

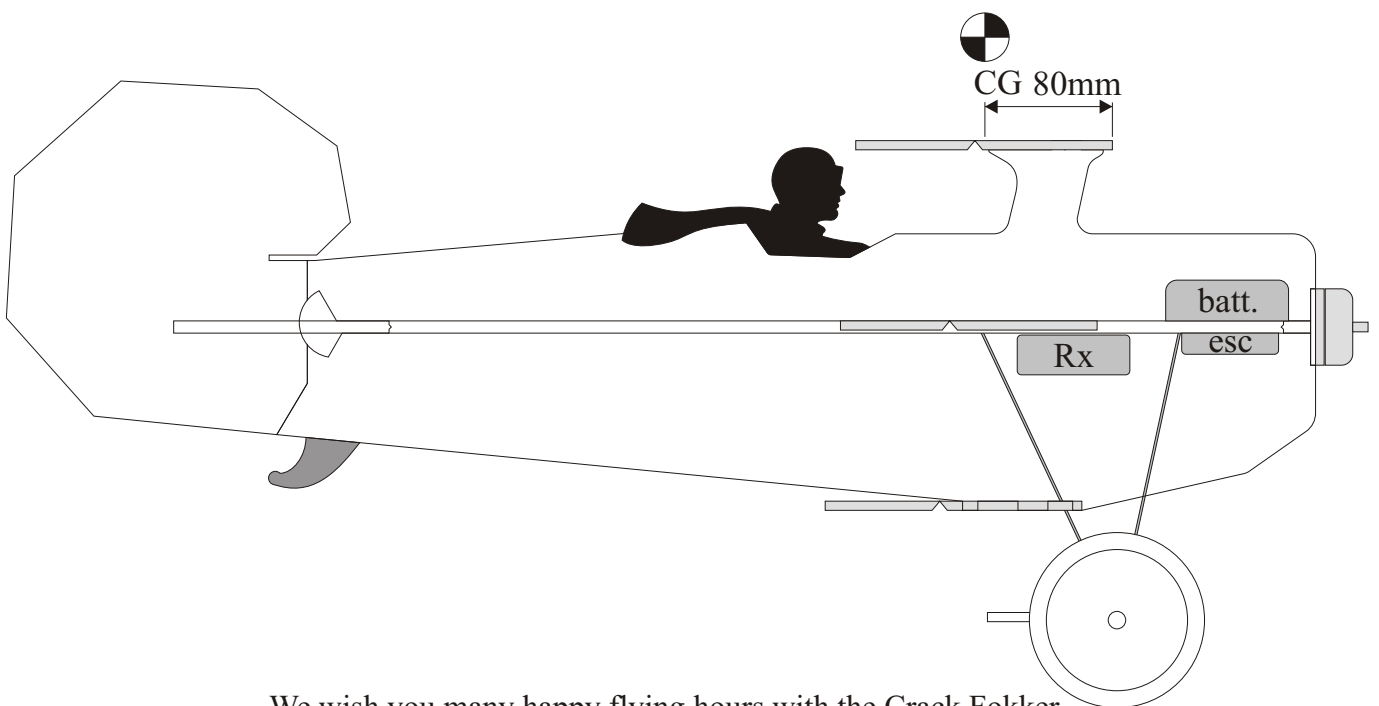
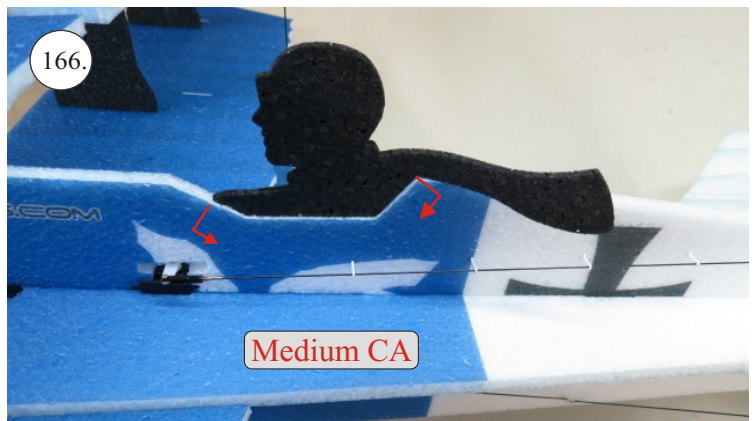
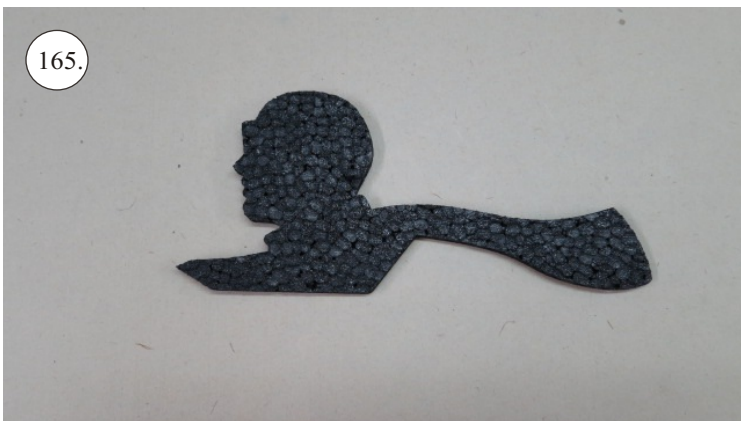
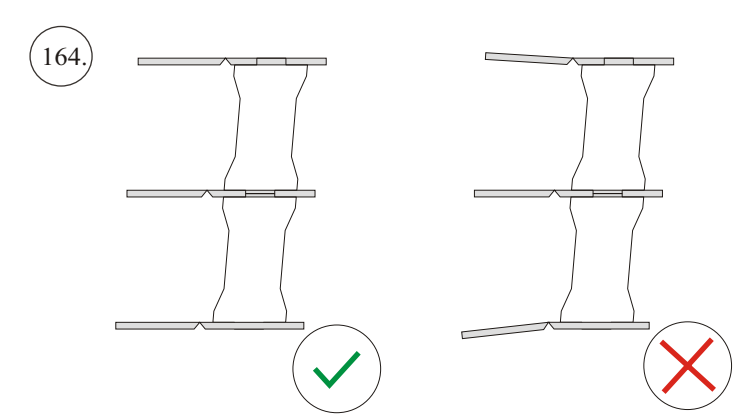
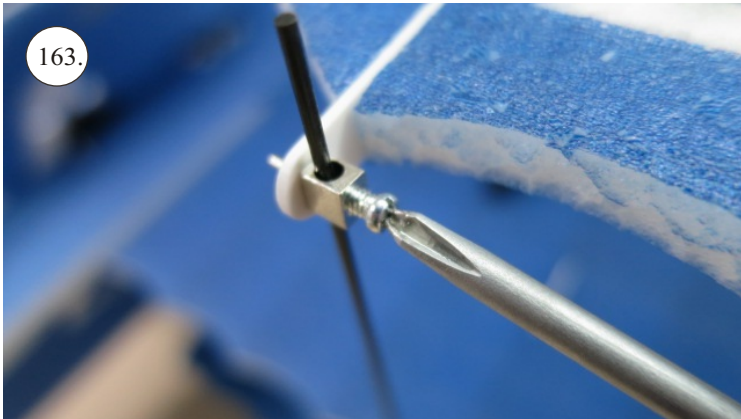
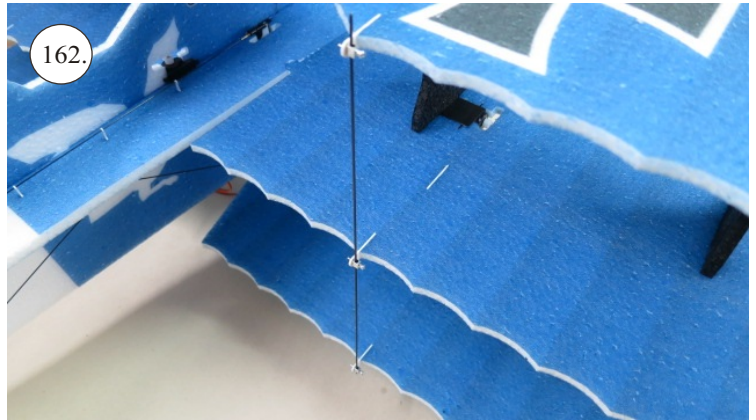
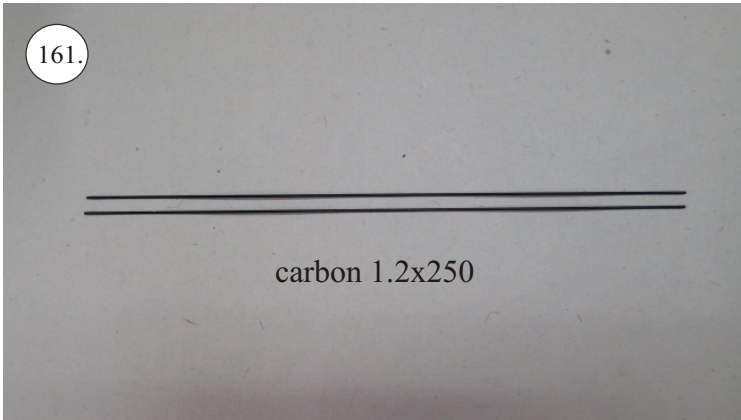

We wish you many happy flying hours with the Crack Fokker.

Your RC Factory team.